

1. Housing components (カバー機構)

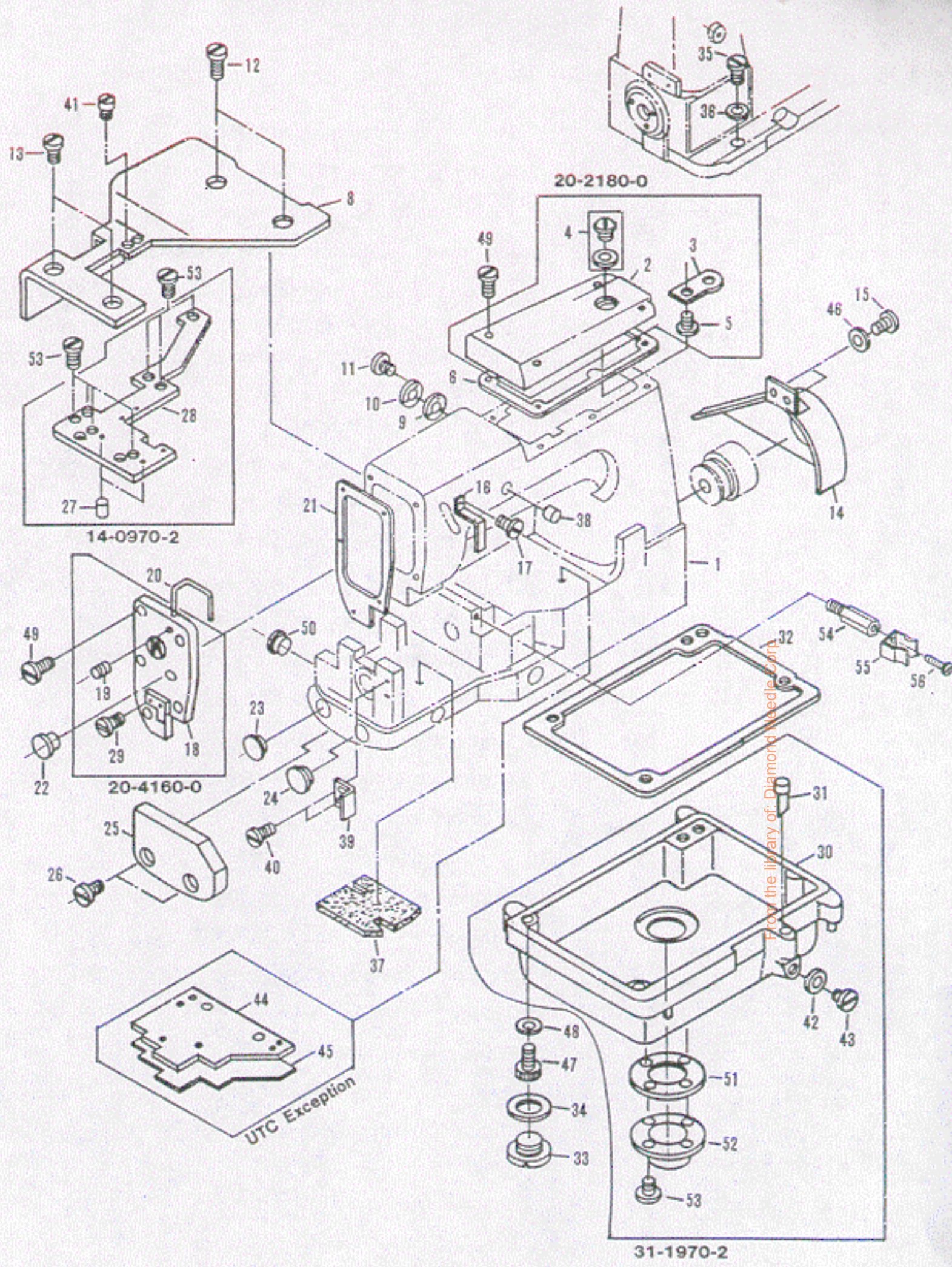

No.	Part No.	Part Name	品 名	Q, ty
1	22-9150-0	Arm bed	アーム・ベッド	1
2	21-2180-0	Crank chamber oil cover G	立ロットカバー	1
3	39-1370-0	Pipe support	配管サポート	1
4	39-2330-0	Oil pot	オイルポット	1
5	84-1610-0	Screw	ネジ	1
6	23-2060-0	Crank chamber gasket	立ロット カバーパッキン	1
8	21-9260-0	Upper base cover	上ベースカバー	1
9	23-2630-0	Oil seal plate gasket C	弓ピン油止めパッキン	1
10	39-1080-0	Oil seal plate B	弓ピン油止め板	1
11	84-3620-0	Screw	ネジ	3
12	84-7630-0	Screw	ネジ	2
13	84-8620-0	Screw	ネジ	2
14	21-4020-0	Pulley cover	H用プーリカバー	1
15	84-5710-0	Screw	ネジ	2
16	21-7110-0	Needle lever eyelet A	弓糸道保護カバー	1
17	84-3630-0	Screw	ネジ	1
18	21-4160-0	Head cover F	面 板	1
19	84-5210-0	Screw	ネジ	1
20	21-7010-0	Needle lever eyelet safety bar	針棒糸道保護カバー	1
21	23-1730-0	Head cover gasket	面板パッキン	1
22	23-1610-0	Head cover oil seal lid	面板油止め蓋	1
23	23-1680-0	Rubber plug for feed rocker shaft	送り土台シャフト蓋ゴム	1
24	23-1690-0	Oil plug	セミシリンダー油止め	1
25	21-3760-0	Side cover	横カバー	1
26	84-5660-0	Screw	ネジ	2
27	71-2510-0	Pin	ピン	2
28	14-0970-2	Needle plate support	針板土台	1
29	84-5710-0	Screw	ネジ	2
30	31-1970-0	Oil Pan	オイルタンク	1
31	39-2160-0	Oil gauge E	オイルゲージE	1
32	23-4050-0	Gasket	オイルタンクパッキン	1
33	87-7560-0	Screw	ネジ	3
34	23-1950-0	Seal for oil tank screw	Oリング	3
35	87-1830-0	Screw	ネジ	1
36	75-4520-0	Washer	ワッシャ	1
37	23-3700-0	Feit	フェルト	1
38	23-1750-0	Rubber plug	ゴム蓋	1
39	25-9060-0	Ruler plate	定規台止め板	1
40	84-5710-0	Screw	ネジ	2
41	84-5610-0	Screw	ネジ	1
42	23-3040-0	Gasket	オイルタンクドレンシール	1
43	87-3110-0	Screw	ネジ	1
44	21-4950-0	Oil reservoir top cover	上油カバー (UTC除外)	1
45	23-4950-0	Gasket for top cover	上油カバーパッキン (UTC除外)	1
46	75-4550-0	Washer	ワッシャ	1
47	87-1710-0	Screw	ネジ	3
48	23-9110-0	Seal washer	シールワッシャ	3
49	84-5660-0	Screw	ネジ	9
50	23-1760-0	Scal Rubber	ブッシュ油止め	1
51	23-9130-0	Oil gasket	オイルフィルターパッキン	1
52	35-9150-0	Oil filter plate	オイルフィルター受	1
53	84-7610-0	Screw	ネジ	7
54	84-5880-0	Screw	ネジ	1
55	79-9120-0	Spring	バネ	1
56	84-5660-0	Screw	ネジ	1

From the library of Diamond Needle Corp

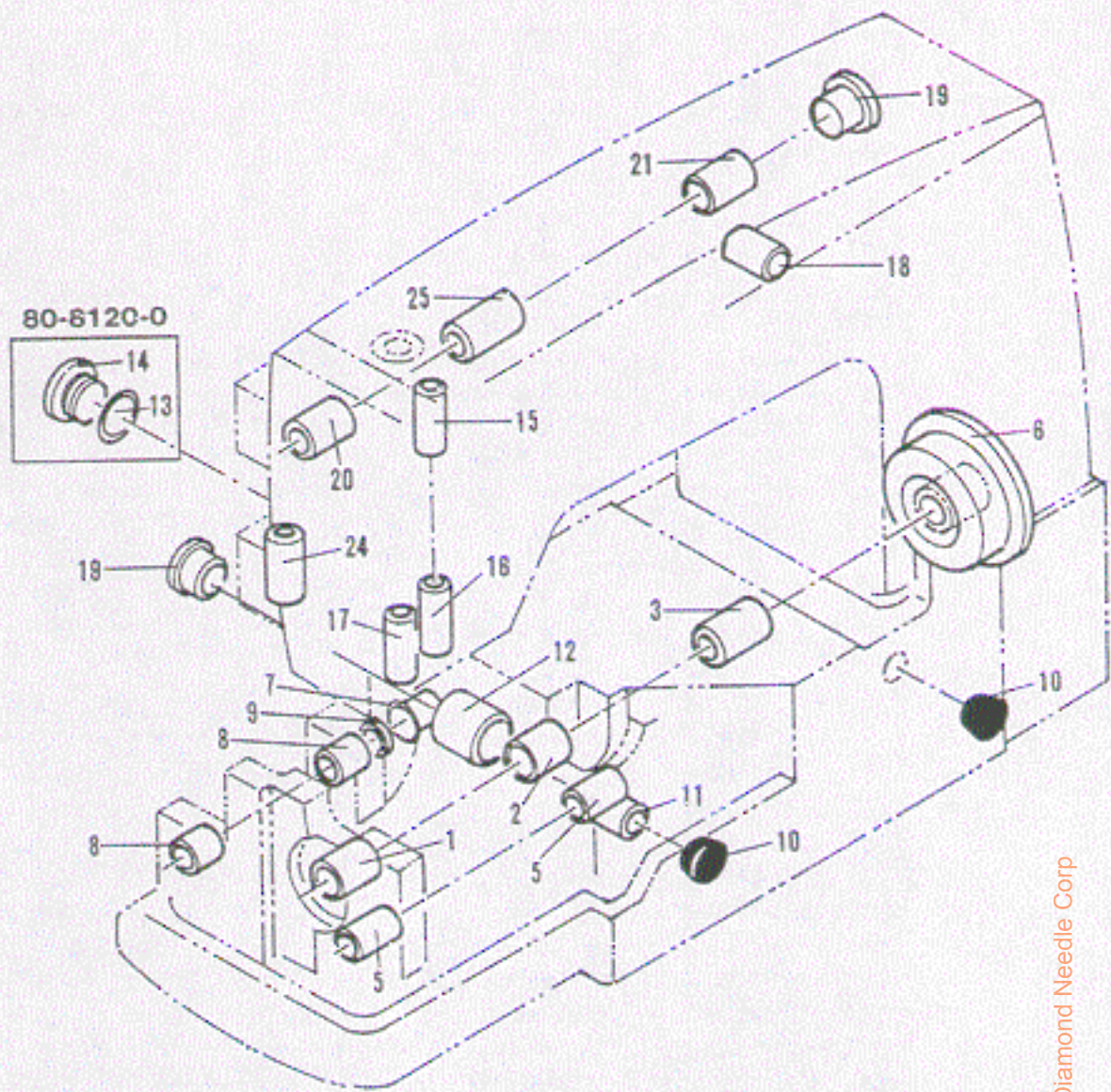

From the library of: Diamond Needle Corp

No.	Part No.	Part Name	品名	Q, ty
1	81-7140-0	Main shaft bushing (front)	下シャフトブッシュ (前)	1
2	81-9060-0	Main shaft bushing (center)	下シャフトブッシュ (中)	1
3	81-8070-0	Main shaft bushing (rear)	下シャフトブッシュ (後)	1
5	81-7350-0	Looper rocker shaft bushing	ルーバー台シャフトブッシュ	3
6	69-3100-2	Flange	フレンジ	1
7	69-7060-0	Seal housing	シールハウジング	1
8	81-7520-0	Feed rocker shaft bushing	送り台シャフトブッシュ	3
9	94-2220-0	Oil seal	送り台シャフトシール	1
10	23-1660-0	Rubber seal (A)	ブッシュ蓋ゴム (A)	2
11	81-2360-0	Looper drive lever shaft bushing (medium)	振り元ブッシュ (中)	1
12	81-2370-0	Looper drive lever shaft bushing (large)	振り元ブッシュ (大)	1
13	23-2980-0	O-ring	シール	1
14	87-8120-0	Screw	ブッシュ蓋 (大)	1
15	81-1820-0	Needle bar bushing (lower)	針棒ブッシュ (下)	1
16	81-1810-0	Needle bar bushing (upper)	針棒ブッシュ (上)	1
17	81-1530-0	Presser bar bushing	押え棒ブッシュ	1
18	06-1370-0	Presser foot lifter lever bushing	押え揚げ土台ブッシュ	1
19	23-2960-0	Seal cover	振り元シール蓋	2
20	81-1080-0	Upper shaft bushing (front)	上シャフトブッシュ (前)	1
21	81-1140-0	Upper shaft bushing (rear)	上シャフトブッシュ (後)	1
24	81-1330-0	Bushing	立シャフトブッシュ	1
25	81-1090-0	Upper shaft bushing (center)	上シャフトブッシュ (中)	1

3. Oil lubrication apparatus (給油機構)

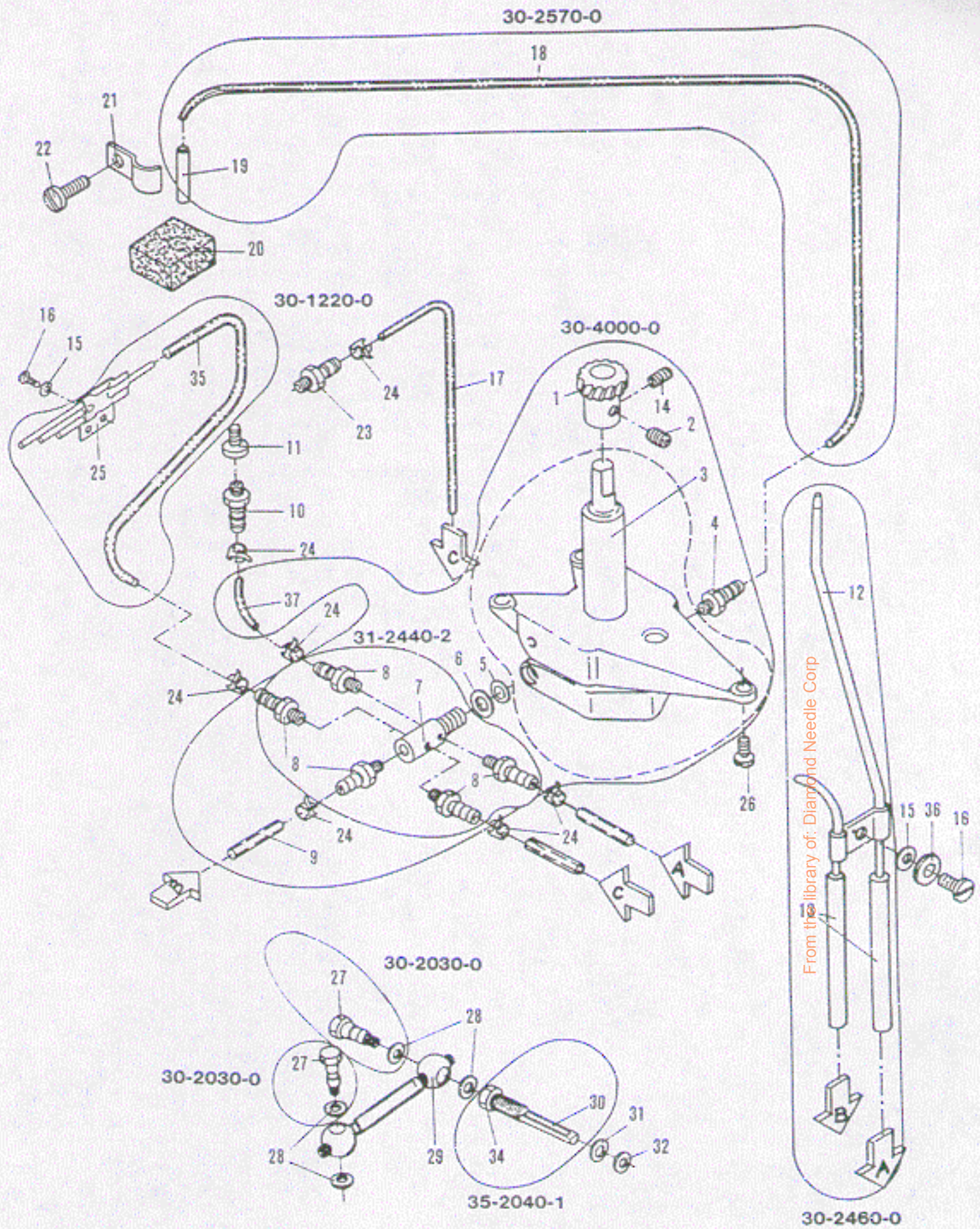

No.	Part No.	Part name	品名	Q. ty
1	31-4090-0	Worm gear	ポンプウォーム歯車	1
2	84-5110-0	Screw	ネジ	1
3	30-0160-0	Pump ass'y	トロコイドポンプセット	1
4	31-3640-0	Pipe joint (E)	ビニールパイプ接手E	1
5	23-1640-0	Gasket	ポンプチューブジョイントシール	1
6	75-4700-0	Washer	ドレンワッシャB	1
7	31-2440-0	Oil tube joint	給油用パイプ接手	1
8	31-3140-0	Pipe joint (C)	ビニールパイプ接手C	5
9	35-3160-0	Tube (200L)	ビニールチューブ200L	1
10	31-3140-0	Pipe joint (C)	ビニールパイプ接手C	1
11	85-5310-0	Screw	ネジ	1
12	35-2460-0	Piping	立ロット用セット配管	1
13	35-3170-0	Tube (290L)	ビニールチューブ290L	2
14	84-5210-0	Screw	ネジ	1
15	23-1600-0	Packing	配管油止めシール	3
16	34-3630-0	Screw	ネジ	3
17	35-3180-0	Tube (440L)	シリコン糸道用ビニールパイプ	1
18	35-3220-0	Tube (600L)	ビニールパイプ小B	1
19	35-2570-0	Pire	面板オイルバックパイプA	1
20	23-3630-0	Felt	面板用フェルトD	1
21	39-1330-0	Support	パイプサポートC	1
22	84-3610-0	Screw	ネジ	1
23	31-3140-0	Pipe joint	ビニールパイプ接手C	1
24	35-4120-0	Pipe clamp	配管チューブ止め金具小	7
25	35-1220-0	Pipe	セバレート配管B	1
26	84-5660-0	Screw	ネジ	3
27	35-2030-0	Screw	ネジ	2
28	23-9110-0	Packing	配管油止めシール	4
29	30-5000-0	Tube coupling	送り台配管用チューブジョイント	1
30	35-2040-0	Screw	オイルフォローネジ	1
31	75-4700-0	Washer	ワッシャB	1
32	23-1640-0	Gasket	ポンプチューブジョイントシール	1
34	86-7610-0	Nut	ナット	1
35	35-3150-0	Vinyl pipe (190L)	ビニールチューブ190L	1
36	75-4550-0	Washer	ワッシャ	1
37	35-3420-0	Pipe	パイプ	1

From the library of Diamond Needle Corp

20-7490-0

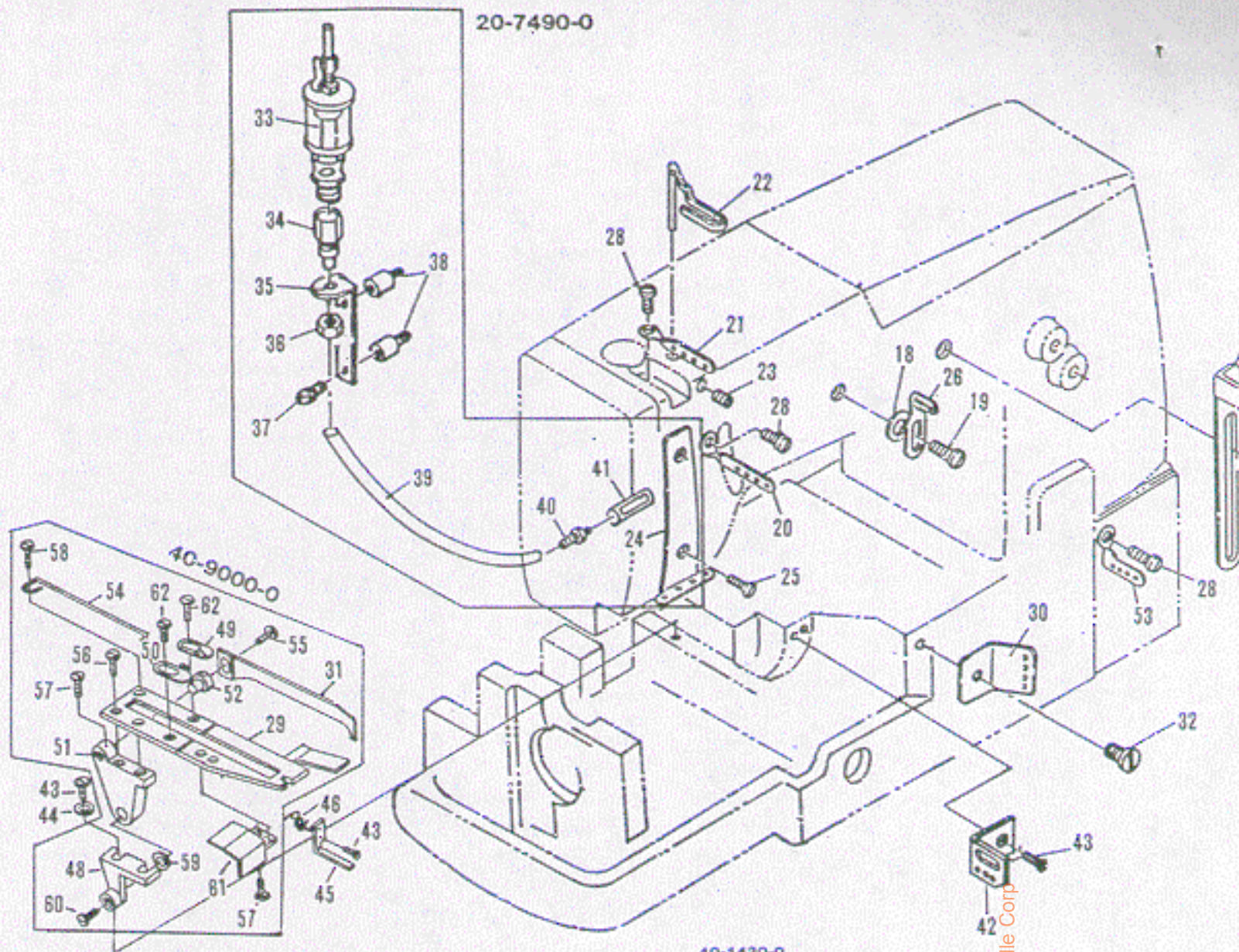

40-9000-0

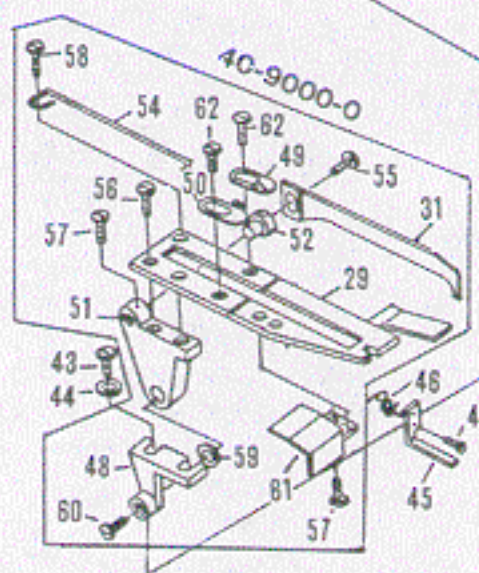

40-1430-0

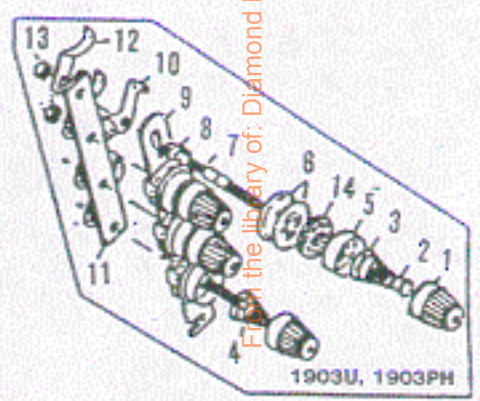
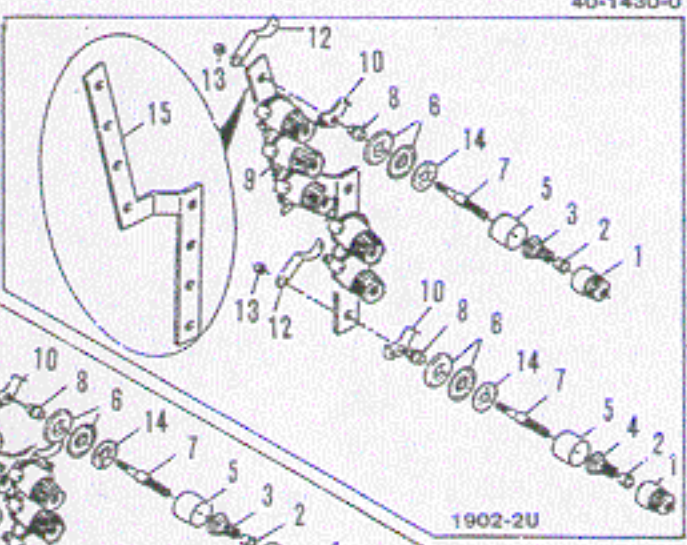

1903U, 1903PH
40-1310-0

40-1440-0

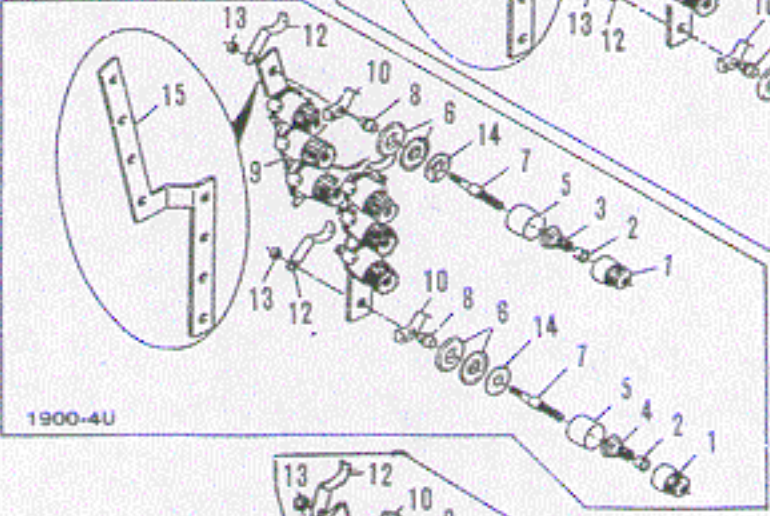

1900-4U

1902-2U

40-1420-0

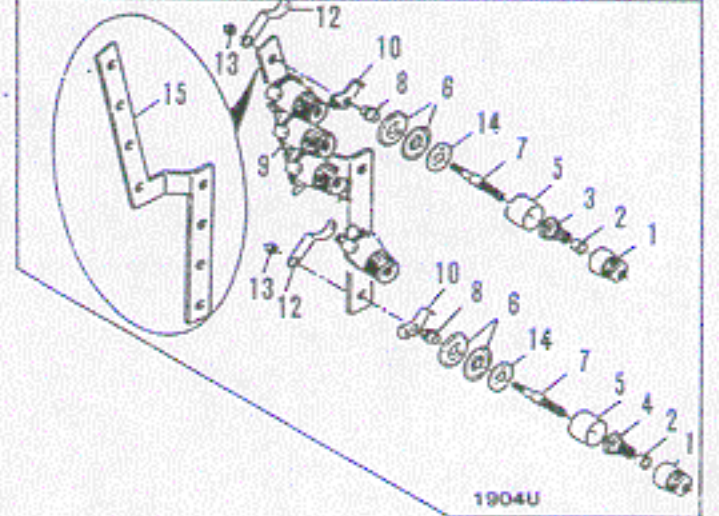

1904U

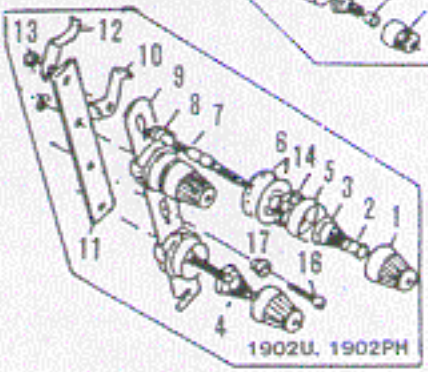

1902U, 1902PH

From the library of: Diamond Needle Corp

1	41-1010-0	Adjusting nut	チャンボン皿小ケース	7	8	3	6	4
2	41-1050-0	Tension disc ratchet	チャンボン皿ラチェット	7	8	3	6	4
3	41-7010-0	Needle thread tension spring	調子ハネ強	4	4	2	4	3
4	41-7020-0	Looper thread tension spring	調子ハネ弱	3	4	1	2	1
5	41-1070-0	Tension disc cover	チャンボン皿大ケース	7	8	3	6	4
6	41-1110-0	Tension disc	チャンボン皿	14	16	6	12	8
7	41-1720-0	Tension post	調子棒 中	7	8	3	6	4
8	41-1310-0	Tension post collar	調子棒カラー	7	8	3	6	4
9	41-113B-0	Tension post support	チャンボン調節板	1	1	1	1	1
10	41-1150-0	Tension post thread eyelet	糸道上	7	8	3	6	4
11	41-121B-0	Tension post holder	チャンボン調節元板	0	0	1	0	1
12	41-1170-0	Thread eyelet	糸道下	7	8	3	6	4
13	86-4110-0	Nut	ナット	5	5	2	5	2
14	23-3240-0	Felt	フェルト	7	8	3	6	4
15	41-123B-0	Tension post holder	チャンボン皿調節元板	1	1	0	1	0
16	84-7840-0	Screw	ネ ジ	0	0	1	0	0
17	41-1320-0	Tension post collar	調子棒カラー	0	0	1	0	0
18	75-4560-0	Washer	ワッシャ	1	1	1	1	1
19	84-5710-0	Screw	ネ ジ	1	1	1	1	1
20	45-1230-0	Needle lever thread eyelet	弓糸道 4	1	1	1	1	1
21	45-1330-0	Needle bar thread eyelet	針棒糸道 4	1	1	1	1	1
22	45-2250-0	Needle thread take-up wire	上糸受け	1	1	1	1	1
23	84-5210-0	Screw	ネ ジ	1	1	1	1	1
24	45-1680-0	Needle thread guide	給油器付糸道	1	1	1	1	1
25	84-4640-0	Screw	ネ ジ	2	2	2	2	2
26	45-1030-0	Needle thread eyelet	上糸糸道 4	2	2	2	2	2
27	45-1050-0	Needle thread eyelet	上糸糸道 8	1	1	1	1	1
28	84-5660-0	Screw	ネ ジ	1	1	1	1	1
29	43-9010-0	Cast off support plate	下糸捌き板	1	1	1	1	1
30	47-2320-0	Thread eyelet 4	下糸糸道 4	1	1	1	1	1
31	43-9020-0	Looper thread retainer	下糸捌き上	1	1	1	1	1
32	84-3740-0	Screw	ネ ジ	2	2	2	2	2
33	27-9060-0	Oiler cup	オイルカップ	1	1	1	1	1
34	27-9050-0	Joint	シリコン配管継手	1	1	1	1	1
35	27-9070-0	Oiler cup mounting bracket	オイルカップ取付板	1	1	1	1	1
36	86-7610-0	Nut	ナット	1	1	1	1	1
37	84-5660-0	Screw	ネ ジ	2	2	2	2	2
38	06-7510-0	Screw	ネ ジ	2	2	2	2	2
39	35-3080-0	Tube	チューブ	1	1	1	1	1
40	31-3140-0	Joint	継手	1	1	1	1	1
41	27-9020-0	Felt	フェルト	1	1	1	1	1
42	06-8440-0	Adjusting bracket	メス上下調節金具	1	1	1	1	1
43	84-5710-0	Screw	ネ ジ	5	5	5	5	5
44	75-4560-0	Washer	ワッシャ	2	2	2	2	2
45	43-9070-0	Take up stop plate	下糸捌き止メ板	1	1	1	1	1
46	79-9060-0	Spring	ハネ	1	1	1	1	1
48	43-9030-0	Cast off plate support plate	下糸捌き元板	1	1	1	1	1
49	43-9040-0	Take up eyelet (Right)	捌き板糸道 (右)	1	1	1	1	1
50	43-9050-0	Take up eyelet (Left)	捌き板糸道 (左)	1	1	1	1	1
51	43-9060-0	Take up mount plate	下糸捌き取付台	1	1	1	1	1
52	43-9080-0	UTC take up stop pin "B"	下糸捌き上取付けピンB	1	1	1	1	1
54	43-9090-0	Take up lower pin	下糸捌き下ピン	1	1	1	1	1
55	84-3610-0	Screw	ネ ジ	1	1	1	1	1
56	84-1640-0	Screw	ネ ジ	2	2	2	2	2
57	84-1150-0	Screw	ネ ジ	1	1	1	1	1
58	84-1610-0	Screw	ネ ジ	1	1	1	1	1
59	75-5280-0	Spring washer	ワッシャ	1	1	1	1	1
60	84-6000-0	Screw	ネ ジ	1	1	1	1	1
61	21-9310-0	Eccentric cover	エキセンカバー	1	1	1	1	1
62	84-1910-0	Screw	ネ ジ	2	2	2	2	2

From the library of: Diamond Needle Corp

4-2. Thread eyelet components (糸調子機構・自動糸切装置) UTC Type

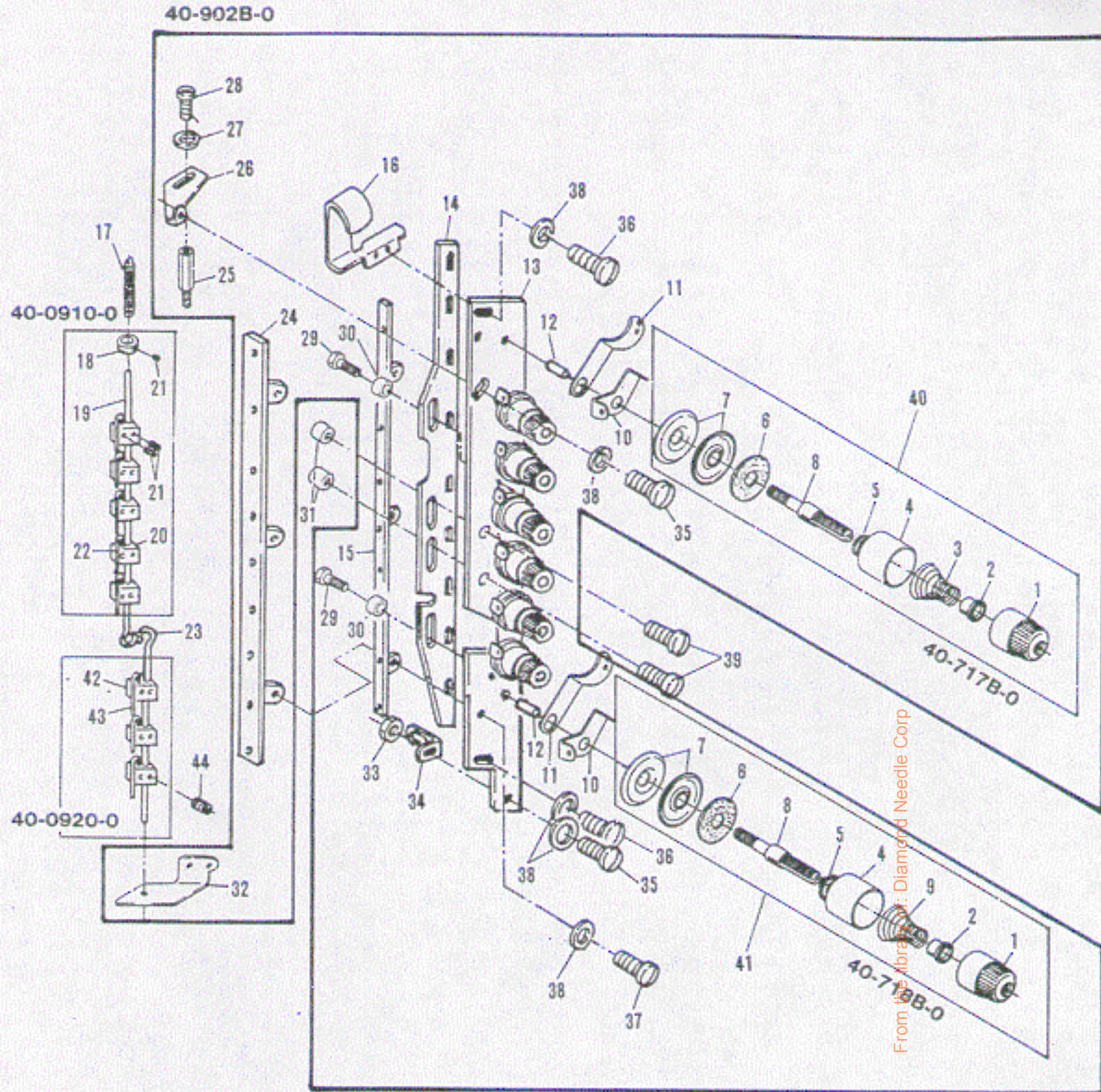

From the Morabai: Diamond Needle Corp

No.	Part No.	Part Name	品名	Q. ty
1	41-1010-0	Adjusting nut	チャンボン皿小ケース	1
2	41-1050-0	Adjusting ratchet	チャンボン皿ラチェット	1
3	41-7010-0	Spring (strong)	調子ハネ (強)	1
4	41-1070-0	Disk cover	大ケース	1
5	33-8020-0	Tension disc washer	チャンボン座金	1
6	23-3240-0	Felt	フェルト	1
7	41-1110-0	Disc	チャンボン皿	2
8	41-1750-0	Tension post	調子芯棒	1
9	41-7020-0	Spring (weak)	調子ハネ (弱)	1
10	41-1150-0	Thread eyelet	糸道上	6
11	41-1170-0	Thread eyelet	糸道下	6
12	06-9440-0	Thread release pin	上糸ユルメピン	8
13	41-943B-0	Tension post holder	チャンボン台	1
14	41-9410-0	Tension post support	チャンボン調節板	1
15	41-9440-0	Thread release guide thread eyelet (right)	糸ユルメ案内糸道	1
16	06-9480-0	Thread release post guide	糸ユルメ棒ガイド	1
17	79-9140-0	Thread release cushion spring	クッションハネ	1
18	75-9410-0	Thread release cushion collar	糸ユルメクッションカラー	1
19	06-9450-0	Thread release post (A)	糸ユルメ棒 (A)	1
20	06-0670-0	Hook holder	糸ユルメスライド	5
21	84-3140-0	Screw	ネジ	11
22	06-0710-0	Hook	糸ユルメ用フック	5
23	06-9460-0	Thread release post (B)	糸ユルメ棒 (B)	1
24	41-9420-0	Thread release guide thread eyelet (left)	糸ユルメ案内糸道	1
25	06-7510-0	Volt	スタッドボルト	1
26	06-940B-0	Tension post bracket	チャンボン台ステー	1
27	75-3980-0	Washer	ワッシャ	1
28	84-5660-0	Screw	ネジ	1
29	84-5590-0	Screw	ネジ	2
30	75-9420-0	Collar	チャンボン台カラー	2
31	75-9430-0	Tension post collar	チャンボン台カラー	2
32	06-947B-0	Tension release post guide	糸ユルメ棒ガイド下	1
33	86-4110-0	Nut	ナット	1
34	06-942B-0	Tension post bracket	チャンボン台ステー下	1
35	84-7620-0	Screw	ネジ	2
36	84-3610-0	Screw	ネジ	4
37	84-3630-0	Screw	ネジ	3
38	75-4550-0	Washer	ワッシャ	6
39	84-7630-0	Screw	ネジ	2
40	40-717B-0	Tension set	チャンボンセット	4
41	40-718B-0	Tension set	チャンボンセット	4
42	06-0670-0	Hook holder	糸ユルメスライド	3
43	06-0710-0	Hook	糸ユルメ用フック	3
44	84-3140-0	Screw	ネジ	6

From the library of Diamond Needle Corp

4-3. Thread tension adjuster 1902U-M (巾狭)/UTC

(糸調子機構、糸ユルメ装置)

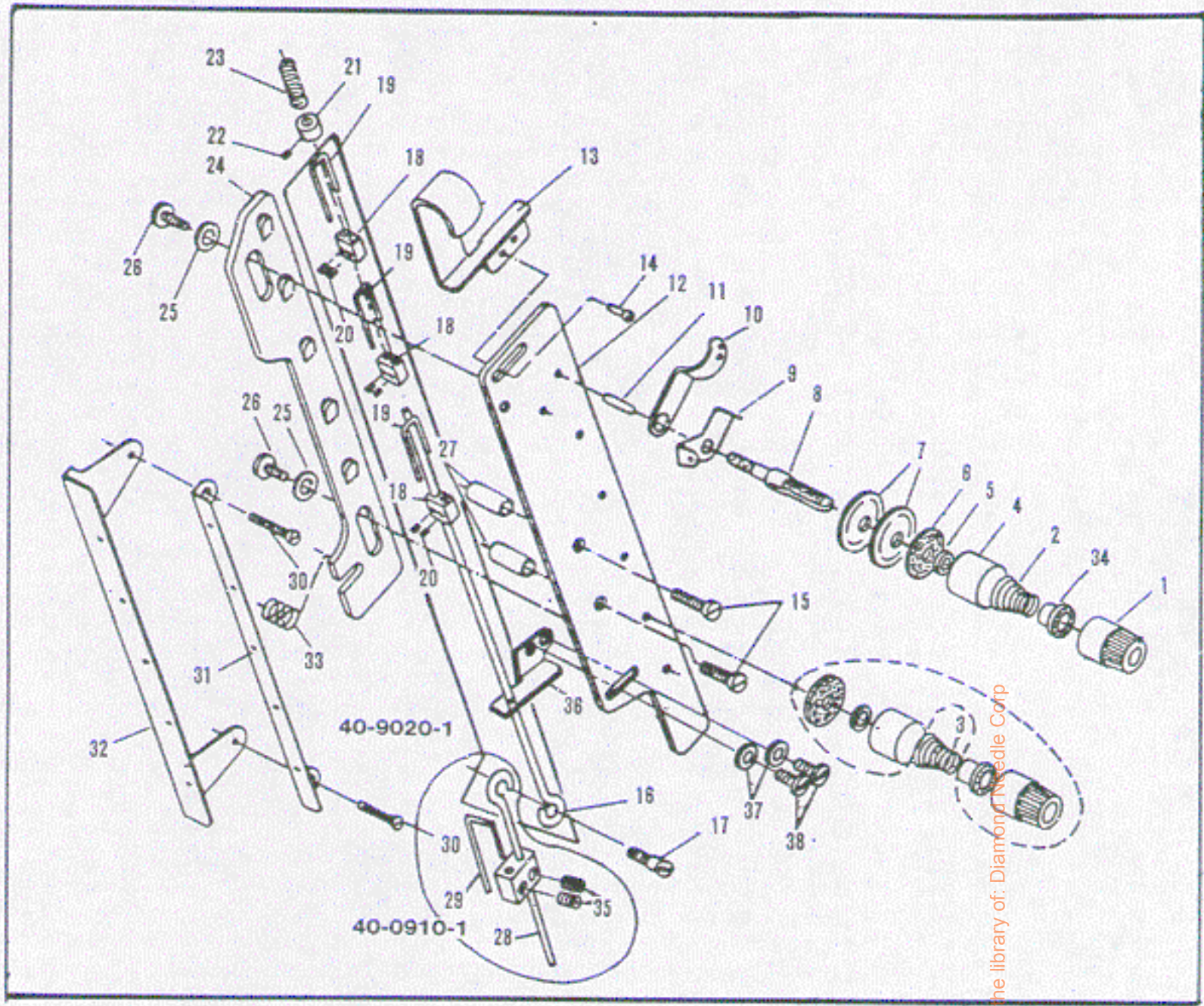

From the library of: Diamond Needle Corp

No.	Part No.	Part Name	品名	Q, ty
1	41-1010-0	Adjusting nut	チャンボン皿小ケース	3
2	41-7010-0	Spring (strong)	チャンボン調子バネ (強)	2
3	41-7020-0	Spring (weak)	チャンボン調子バネ (弱)	1
4	41-1070-0	Disc cover	大ケース	3
5	33-8020-0	Tension disc washer	チャンボン座金	3
6	23-3240-0	Felt	フェルト	3
7	41-1110-0	Disc	チャンボン皿	6
8	41-1750-0	Tension post	上糸調子棒	3
9	41-1150-0	Thread eyelet	糸道上	3
10	41-1170-0	Thread eyelet	糸道下	3
11	06-9440-0	Thread release pin	上糸ユルメピン	3
12	41-9330-0	Tension post holder	チャンボン元台	1
13	06-9480-0	Thread release post guide	糸ユルメ棒ガイド上	1
14	84-3610-0	Screw	ネジ	2
15	84-7650-0	Screw	ネジ	2
16	06-9390-0	Thread release post B	糸ユルメ棒B	1
17	84-7920-0	Screw	ネジ	1
18	06-0670-0	Hook holder	糸ユルメスライド	3
19	06-0710-0	Hook	糸ユルメ用フック	3
20	84-3140-0	Screw	ネジ	6
21	75-9410-0	Thread release cushion collar	糸ユルメクッションカラー	1
22	84-3140-0	Screw	ネジ	1
23	79-9140-0	Thread release cushion spring	糸ユルメクッションバネ	1
24	41-9310-0	Tension post support	チャンボン調整板	1
25	75-9420-0	Tension post collar	チャンボンカラー	2
26	84-5590-0	Tension post slide screw	ネジ	2
27	75-9430-0	Tension post collar	チャンボンカラー	2
28	06-9390-0	Tension release bar	糸ユルメ棒	1
29	06-0710-0	Hook	糸ユルメフック	1
30	84-3740-0	Screw	ネジ	2
31	41-9340-0	Thread release guide thread eyelet (right)	糸ユルメ案内糸道 (右)	1
32	41-9330-0	Thread release guide thread eyelet (left)	糸ユルメ案内糸道 (左)	1
33	79-1640-0	Spring	バネ	1
34	41-1050-0	Tension disc ratchet	チャンボン皿ラチェット	3
35	84-3140-0	Screw	ネジ	2
36	06-947B-0	Tension release post guide	糸ユルメ棒ガイド下カラー	1
37	75-4550-0	Washer	ワッシャ	2
38	84-3610-0	Screw	ネジ	2

From the library of: Diamond Needle Corp

5. Needle lever crank (弓・クランク機構)

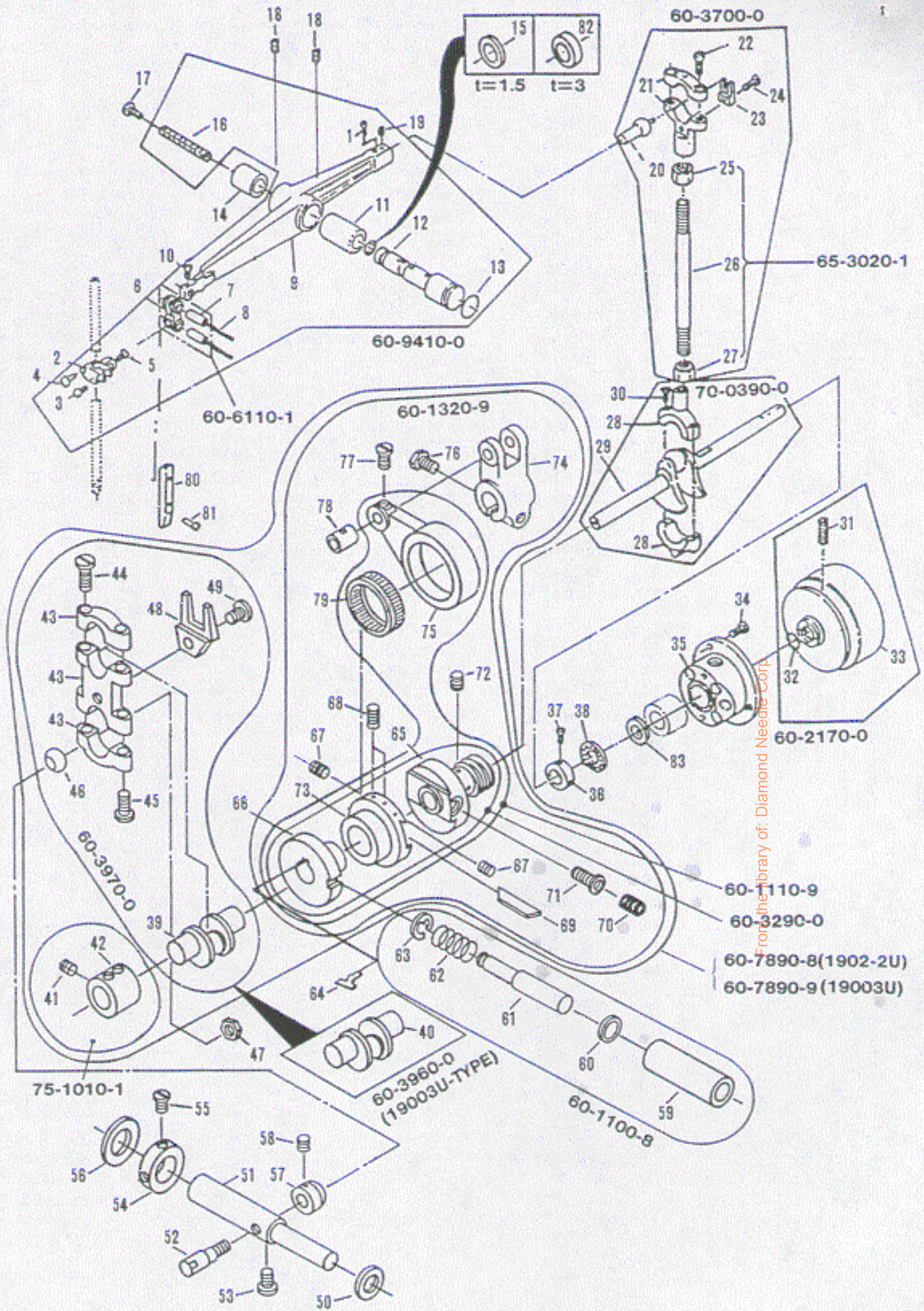

From the library of: Diamond Needle Corp.

1	85-1130-0	Screw	ネ ジ	1	1
2	73-1210-1	Needle bar connection	針棒コネクタガイド	1	1
3	84-3630-0	Screw	ネ ジ	1	1
4	84-6150-0	Screw	ネ ジ	1	1
5	84-3650-0	Screw	ネ ジ	1	1
6	66-1110-0	Needle bar connecting link	連結メカネ	1	1
7	71-4320-0	Needle bar connecting link pin	ダルマピン	2	2
8	23-3410-0	Felt	フェルト	2	2
9	69-1050-2	Needle lever	弓	1	1
10	84-3660-0	Screw	ネ ジ	1	1
11	81-1130-0	Needle lever bushing	ブッシュ	1	1
12	71-9330-0	Needle lever stud	弓ピン	1	1
13	23-1950-0	O-ring	Oリング	1	1
14	81-4120-0	Needle lever stud bushing	ブッシュ	1	1
15	75-3320-0	Washer	ワッシャ	1	1
16	23-3960-0	Felt	フェルト	1	1
17	85-1810-0	Screw	ネ ジ	1	1
18	85-1140-0	Screw	ネ ジ	2	2
19	85-2120-0	Screw	ネ ジ	1	1
20	61-7110-U	Needle lever connecting rod	立ロッド玉	1	1
21	63-7130-1	Ball joint for connecting rod	立ロッド小	1	1
22	84-5670-0	Screw	ネ ジ	2	2
23	69-1210-0	Eccentric guide fork	ロッド撥れ止め	1	1
24	84-5720-0	Screw	ネ ジ	1	1
25	86-7410-0	Nut	ナット	1	1
26	65-3020-0	Connecting bar	連結棒	1	1
27	86-7420-0	Nut	ナット	1	1
28	63-6210-1	Ball joint for crank shaft	立ロッド大	1	1
29	71-8960-0	Crank shaft 9HB	クランクシャフト	1	1
30	84-5680-0	Screw	ネ ジ	2	2
31	85-1140-0	Screw	ネ ジ	2	2
32	23-1970-0	O-ring	Oリング	1	1
33	69-2170-0	Pulley	プーリ	1	1
34	84-5660-0	Screw	ネ ジ	3	3
35	69-3100-2	Flang E	フレンジ	1	1
36	75-1120-1	Crank shaft collar	クランクシャフトカラー小	1	1
37	84-5630-0	Screw	ネ ジ	2	2
38	92-2310-0	Bearing (13.45φ)	13.45φスラストベアリング	1	1
39	71-8990-0	Crank shaft for looper	ルーバー振り元クランク	1	1
40	71-8980-0	Crank shaft for looper	ルーバー振り元クランク	1	1
41	85-1130-0	Screw	ネ ジ	6	6
42	75-1010-0	Joint collar	クランクジョイントカラー	1	1
43	63-5160-1	Looper driving lever ball joint F	ルーバー振り元ロッドF	1	1
44	84-5680-0	Screw	ネ ジ	2	2
45	84-5720-0	Screw	ネ ジ	2	2
46	61-8430-U	Looper drive lever joint ball	ルーバー連結ボール	1	1
47	86-5090-0	Nut	ナット	1	1
48	69-1260-0	Eccentric guide fork	振り元ロッド撥り止め	1	1
49	84-5910-0	Screw	ネ ジ	1	1
50	75-3220-0	Washer	ワッシャ	1	1
51	71-6150-0	Looper driving shaft	ルーバー振り元軸C	1	1
52	71-6160-0	Looper driving rod pin	ルーバー振り元ロッドピン	1	1
53	85-1140-0	Screw	ネ ジ	1	1
54	75-1070-1	Collar	ルーバー振り元カラー	1	1
55	85-2120-0	Screw	ネ ジ	1	1
56	75-3320-0	Washer	ワッシャ	1	1
57	75-1480-0	Looper driving space collar	ルーバー振り元スペースカラー	1	1
58	84-5210-0	Screw	ネ ジ	1	1
59	69-2920-0	Push button	調節ピンハウジング	1	1
60	23-1900-0	O-ring (10φ)	10φOリング	1	1
61	69-2930-0	Push-button pin	送りエキセン調節ピン	1	1
62	79-4610-0	Push-button spring	ブッシュボタンコイルバネ	1	1
63	93-2050-0	Push-button washer	ブッシュボタン止め輪	1	1
64	79-5160-0	Plate spring	送り調節ストップ板バネ	1	1
65	69-2150-0	Feed crank adjusting port eccentric	ウォームエキセンホイール	1	1
66	61-3300-0	Feed roller eccentric	送り調節エキセン	1	1
67	87-1390-0	Screw	ネ ジ	2	2
68	87-1350-0	Screw	ネ ジ	2	2
69	69-7020-0	Spacer	エキセンライナー	1	1
70	87-1390-0	Screw	ネ ジ	1	1
71	87-1700-0	Screw	ネ ジ	1	1
72	85-1130-0	Screw	ネ ジ	2	2
73	61-3290-0	Feed roller regulation	送りエキセン	1	1
74	67-3190-0	Feed roller shaft lever	送り駆動レバー	1	1
75	63-3560-0	Feed roller driving rod	送りダルマF	1	1
76	84-6120-0	Screw	ネ ジ	1	1
77	84-3660-0	Screw	ネ ジ	1	1
78	71-4340-0	Feed roller driving rod pin	ダルマピン	1	1
79	91-2720-0	Feed roller eccentric roller bearing	送りエキセンベアリング	1	1
80	69-1170-0	Needle bar guide plate	針棒案内板	1	1
81	84-5740-0	Screw	ネ ジ	2	2
82	75-3310-0	Washer	ワッシャ	1	1
83	75-3270-0	Washer	ワッシャ	1	1

50-5910-2
(50-5910-3, 1902U-M TYPE)

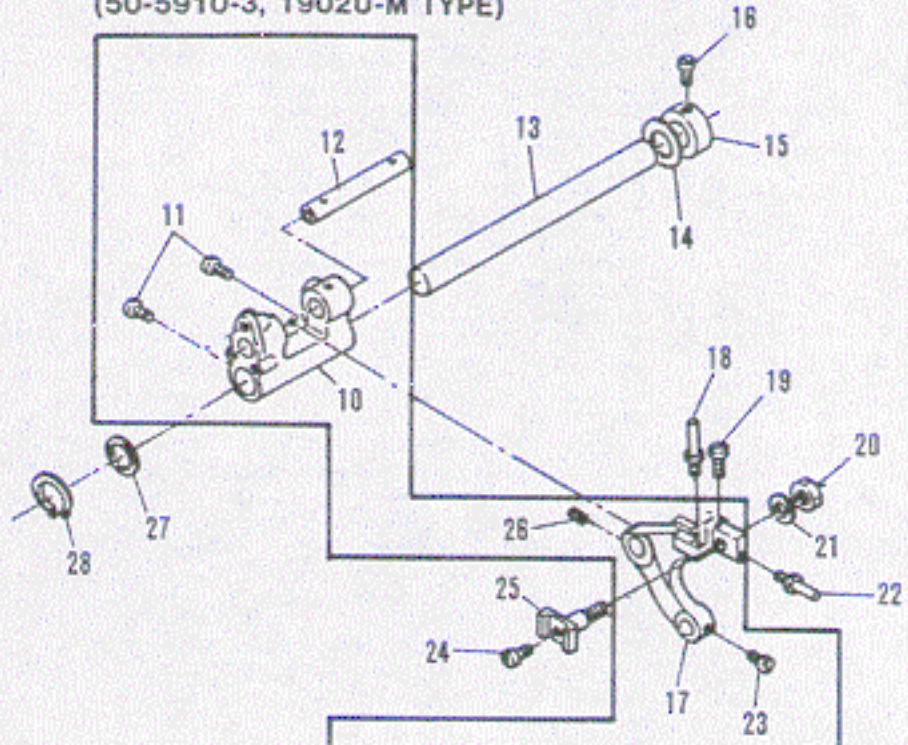

70-8000-0

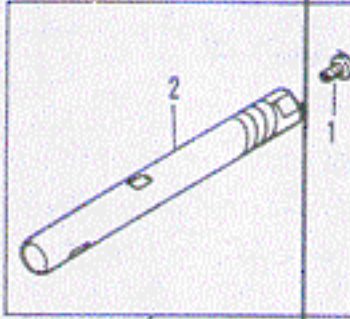

60-0900-0

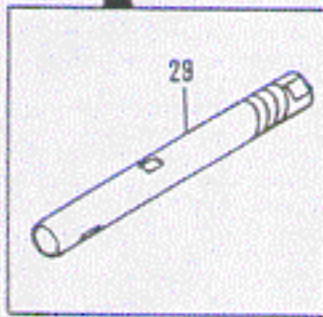
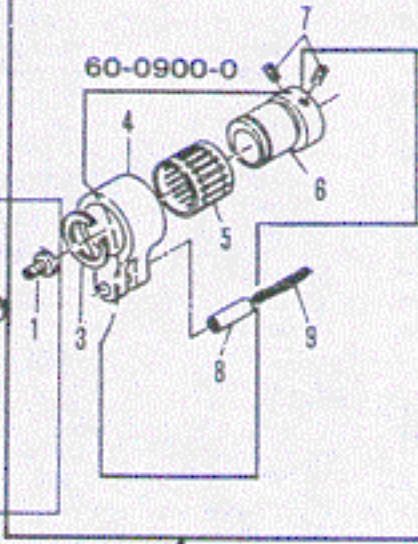

70-1990-0
1900PH-Type

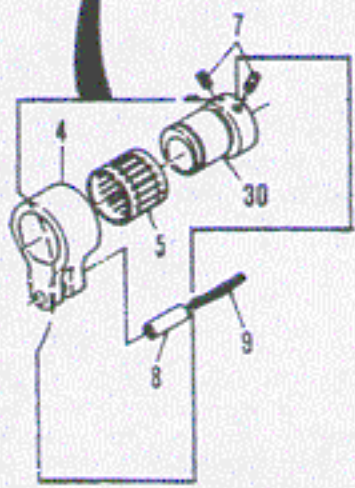

(60-0800-0
1902U-M Type)

From the library of: Diamond Needle Corp

No.	Part No.	Part Name	品名	U-Type	PH-Type
1	84-5760-0	Screw	ネジ	1	1
2	71-8000-0	Main shaft	前下シャフト	1	
3	93-4060-0	Snap ring	サークリップ	1	1
4	63-2320-U	Looper avoid eccentric link	エキセンダルマB	1	1
5	91-4060-0	Bearing	エキセンベアリング	1	1
6	61-3220-0	Feed eccentric B 0.9	送りエキセン玉B	1	1
7	84-5210-0	Screw	ネジ	2	2
8	71-4310-0	Feed rocker eccentric link pin	ダルマピン	1	1
9	23-3410-0	Felt	フェルト	1	1
10	55-0500-0	Feed rocker	一枚送り元台	1	1
11	84-7660-0	Screw	ネジ	2	2
12	71-5310-0	Shaft	後送り歯取付台シャフト	1	1
13	71-6490-0	Feed rocker arm shaft	送り土台シャフト	1	1
14	75-3720-0	Washer	ワッシャ	1	1
15	75-1320-1	Collar	10.34φシャフトカラー	1	1
16	84-8160-0	Screw	ネジ	1	1
17	55-1920-0	Feed rocker	一枚送り土台	1	1
18	84-1770-0	Screw	ネジ	1	1
19	84-3680-0	Screw	ネジ	1	1
20	86-5010-0	Nut	ナット	1	1
21	75-3810-0	Washer	ワッシャ	1	1
22	84-1760-0	Screw	ネジ	1	1
23	84-3660-0	Screw	ネジ	1	1
24	84-5880-0	Screw	ネジ	1	1
25	55-0510-0	Rear feed dog holder	送り歯取付台B	1	1
26	84-7120-0	Screw	ネジ	1	1
27	75-3720-0	Washer	ワッシャ	1	1
28	93-2610-0	C-ring	C形止メ輪	1	1
29	71-7990-0	Main shaft (PH-Type)	前下シャフト		1
30	61-3120-0	Feed eccentric 0.79 1902U-M Type	送りエキセン玉0.79巾狭タイプ		

From the library of: Diamond Needle Corp

7-1. Looper (ルーパー機構) 1900PH, 1900U, 1902-2U Type

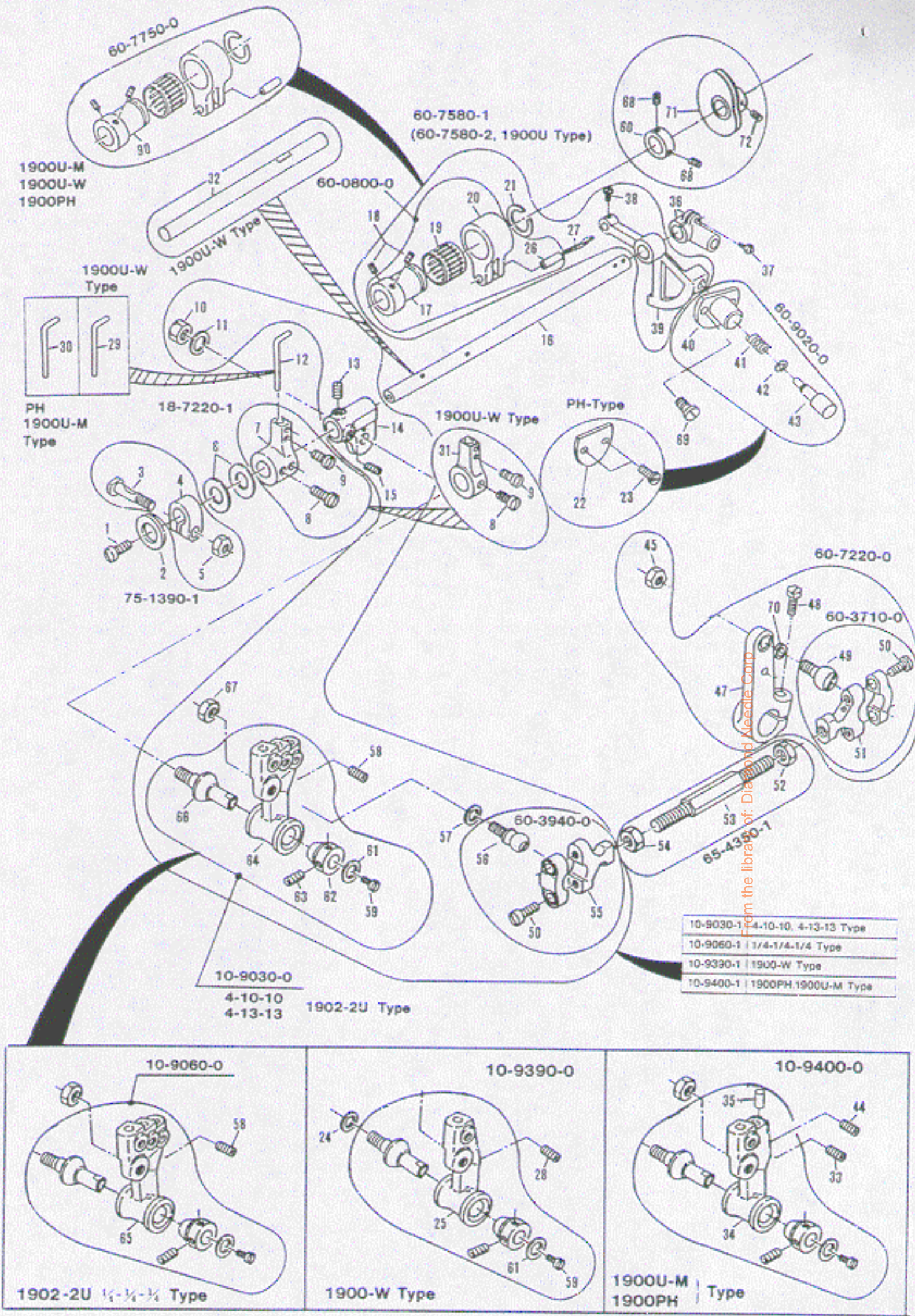

From the library of: Diamond Needle Corp

10-9030-1	4-10-10, 4-13-13 Type
10-9060-1	1/4-1/4-1/4 Type
10-9390-1	1900-W Type
10-9400-1	1900PH, 1900U-M Type

1	84-7610-0	Screw	ネジ	1
2	75-4550-0	Washer	ワッシャ	1
3	71-4540-0	Stop pin	締めカラー止ピン	1
4	75-1390-1	Collar	ルーバー台シャフトカラー	1
5	86-3140-0	Nut	ナット	1
6	75-3720-0	Washer	ワッシャ	2
7	18-7220-0	Needle bar guide bracket	針ガイドブラケット	1
8	84-8160-0	Screw	ネジ	1
9	84-3620-0	Screw	ネジ	1
10	86-5020-0	Nut	ナット	1
11	75-3810-0	Washer	ワッシャ	1
12	18-9110-0	Needle bar guide	針ガイド	1
13	84-7660-0	Screw	ネジ	1
14	19-3030-0	Looper rocker	ルーバー元台	1
15	84-7670-0	Screw	ネジ	1
16	71-9660-0	Looper holder shaft	ルーバー台シャフト	1
17	61-3120-0	Looper avoid eccentric	針返しエキセン玉	1
18	84-5210-0	Screw	ネジ	2
19	91-4060-C	Eccentric bearing	エキセンベアリング	1
20	63-2320-U	Eccentric link	エキセンダルマ	1
21	93-4060-0	Snap ring	サークリップ	2
22	39-1900-0	Cover (PH-Type)	カバー (PHタイプ専用)	1
23	84-3610-0	Screw (PH-Type)	ネジ (PHタイプ専用)	2
24	75-3630-0	Washer (1900-W Type)	ワッシャ (1900-W専用)	1
25	19-3290-0	Looper hold (1900-W Type)	ルーバー台 (1900-W専用)	1
26	71-4310-0	Connecting link pin	ダルマピン	1
27	23-3410-0	Felt	メガネピンフェルト	1
28	84-6160-0	Screw (1900-W Type)	ネジ (1900-Wタイプ)	1
29	18-7270-0	Front needle guard	針ガイド (1900U-Wタイプ)	1
30	18-7250-0	Needle guard	針ガイド (1900U-Mタイプ)	1
31	18-9360-0	Needle guard bracket	針ガイドブラケット (1900U-Wタイプ)	1
32	71-9120-0	Looper holder shaft	ルーバー台シャフト (1900U-Wタイプ)	1
33	84-6160-0	Screw (1900U-M Type)	ネジ (1900U-Mタイプ)	1
34	19-3150-0	Looper holder (1900U-M Type)	ルーバー台 (1900U-M Type)	1
35	71-2160-0	Pin (1900U-M Type)	ピン (1900U-Mタイプ)	1
36	67-9520-1	Stop lever	ストップレバー	1
37	84-8140-0	Screw	ネジ	1
38	84-3660-0	Screw	ネジ	1
39	67-1330-0	Looper avoid lever	ルーバーストップ装置針返しレバー	1
40	69-9020-0	Stud holder	ルーバー引出スタッドホルダー	1
41	79-9110-0	Spring	バネ	1
42	93-2050-0	E-ring	ブッシュボタン止め輪	1
43	69-9010-0	Pin	ルーバー引出スタッド	1
44	84-1610-0	Screw (1900U-M Type)	ネジ (1900U-Mタイプ)	1
45	86-4110-0	Nut	ナット	1
47	67-9530-1	Looper driving lever	ルーバー振元レバー	1
48	85-2100-0	Screw	ネジ	1
49	61-8230-U	Looper connecting ball joint-left	連結ロッド玉	1
50	84-5670-0	Screw	ネジ	4
51	63-8110-1	Looper connecting link-right	連結ロッド右	1
52	86-4110-0	Nut	ナット	1
53	65-4350-0	Connecting bar	連結棒セット	1
54	86-4120-0	Nut	ナット	1
55	63-8120-1	Looper connecting link-left	連結ロッド左	1
56	61-9010-U	Connecting rod	ルーバー連結ロッド	1
57	75-4530-0	Washer	ワッシャ	1
58	84-6160-0	Screw (1902-2U Type)	ネジ (1902-2Uタイプ)	3
59	84-3610-0	Screw	ネジ	1
60	75-1140-1	Collar	カラー	1
61	75-4520-0	Washer	ワッシャ	1
62	81-4030-1	Taperd pin bushing	テーパピン押ブッシュ	1
63	84-5210-0	Screw	ネジ	2
64	19-3160-0	Looper holder (4-10-10,4-13-13)	ルーバー台 (4-10-10,4*13-13)	1
65	19-3520-0	Looper holder (1/4-1/4-1/4)	ルーバー台(1/4-1/4-1/4)	1
66	71-9080-0	Looper holder tapered pin	ルーバー台テーパピン	1
67	86-4130-0	Nut	ナット	1
68	84-5110-0	Screw	ネジ	2
69	84-5710-0	Screw	ネジ	2
70	75-4010-0	Washer	ワッシャ	1
71	49-1410-1	Looper thread take-up cam	ハマグリ	1
72	84-7110-0	Screw	ネジ	2
73	61-3140-0	Looper avoid eccentric 0.75 (1902U, 1900PH Type)	エキセン玉	1

7-2. Looper (ルーバー機構) 1904U, 19003U TYPE

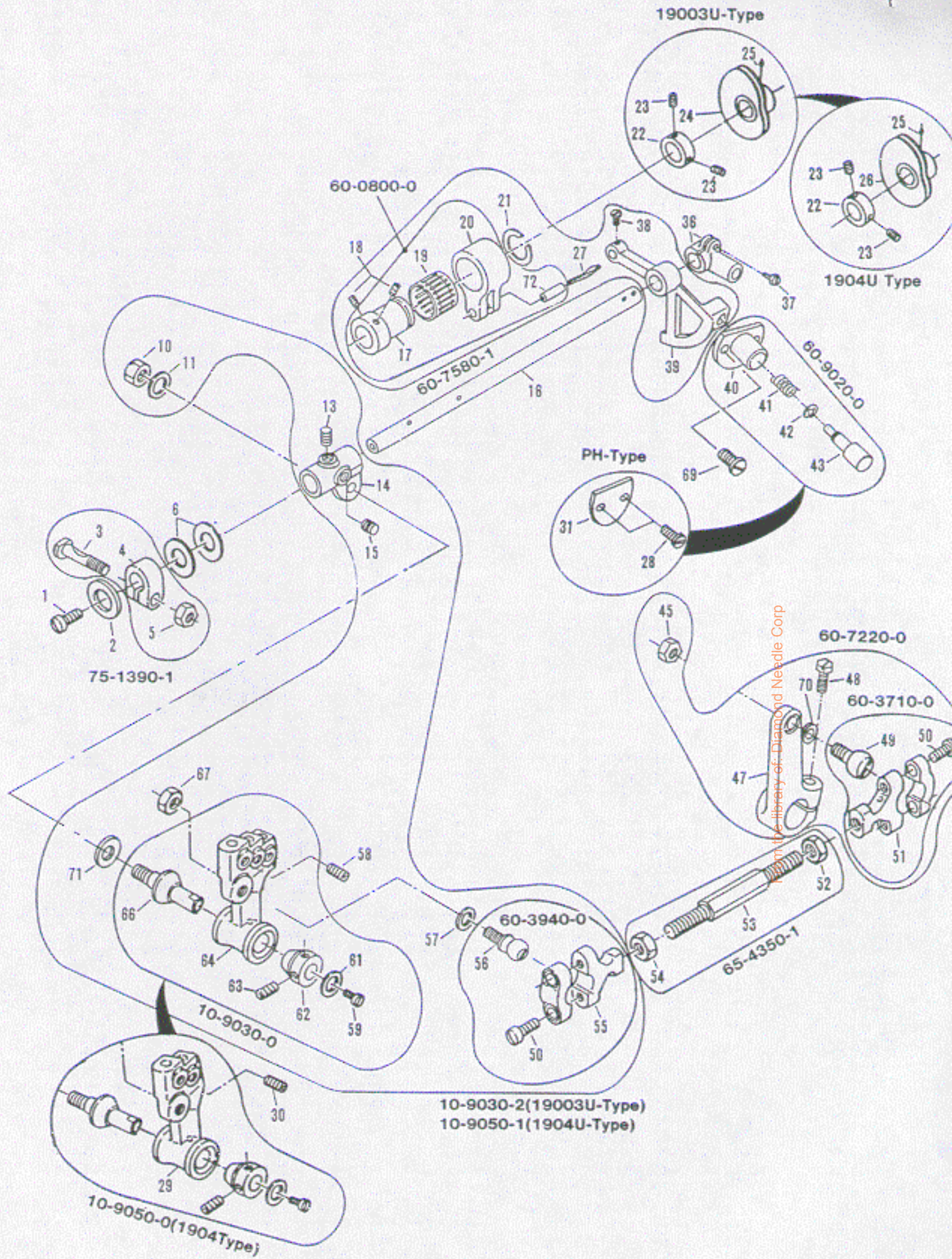

No.	Part No.	Part Name	品名	Q, ty
1	84-7610-0	Screw	ネジ	1
2	75-4550-0	Washer	ワッシャ	1
3	71-4540-0	Stop pin	締めカラー止ピン	1
4	75-1390-1	Coller	ルーバー台シャフトカラー	1
5	86-3140-0	Nut	ナット	1
6	75-3720-0	Washer	ワッシャ	2
10	86-5020-0	Nut	ナット	1
11	75-3810-0	Washer	ワッシャ	1
13	84-7660-0	Screw	ネジ	1
14	19-3050-0	Looper rocker	ルーバー元台	1
15	84-7670-0	Screw	ネジ	1
16	71-9660-0	Looper holder shaft	ルーバー台シャフト	1
17	61-3120-0	Looper avoid eccentric	針返しエキセン玉	1
18	84-5210-0	Screw	ネジ	2
19	91-4060-0	Eccentric bearing	エキセンベアリング	1
20	63-2320-U	Eccentric link	エキセンダルマ	1
21	93-4060-0	Snap ring	サークリップ	2
22	75-1140-1	Collar	カラー	1
23	84-5110-0	Screw	ネジ	1
24	49-1420-1	Looper thread double disc take up	ハマグリ	1
25	84-7110-0	Screw	ネジ	1
26	49-1410-1	Looper thread double disc take up	ハマグリ1904Uタイプ	1
27	23-3410-0	Felt	メガネピンフェルト	1
28	84-3610-0	Screw (PH-Type)	ネジ (PHタイプ専用)	2
29	19-3140-0	Looper holder (1904U-Type)	ルーバー台 (1904U専用)	1
30	84-6160-0	Screw (1904U-Type)	ネジ	2
31	39-1900-0	Cover (PH-Type)	カバー (PHタイプ専用)	1
36	67-9520-1	Stop lever	ストップレバー	1
37	84-8140-0	Screw	ネジ	1
38	84-3660-0	Screw	ネジ	1
39	67-1330-0	Looper avoid lever	ルーバーストップ装置針返しレバー	1
40	69-9020-0	Stud holder	ルーバー引出スタッドホルダー	1
41	79-9110-0	Spring	バネ	1
42	93-2050-0	E-ring	ブッシュボタン止め輪	1
43	69-9010-0	Pin	ルーバー引出スタッド	1
45	86-4110-0	Nut	ナット	1
47	67-9530-1	Looper driving lever	ルーバー振元レバー	1
48	85-2100-0	Screw	ネジ	1
49	61-8230-U	Looper connecting ball joint-left	連結ロッド玉	1
50	84-5670-0	Screw	ネジ	4
51	63-8110-1	Looper connecting link-right	連結ロッド右	1
52	86-4110-0	Nut	ナット	1
53	65-4350-0	Connecting bar	連結棒セット	1
54	86-4120-0	Nut	ナット	1
55	63-8120-1	Looper connecting link-left	連結ロッド左	1
56	61-9010-U	Connecting rod	ルーバー連結ロッド	1
57	75-4530-0	Washer	ワッシャ	1
58	84-6160-0	Screw (19003U-Type)	ネジ (19003U-タイプ)	3
59	84-3610-0	Screw	ネジ	1
61	75-4520-0	Washer	ワッシャ	1
62	81-4030-1	Taperd pin bushing	テーパピン押しブッシュ	1
63	84-5210-0	Screw	ネジ	2
64	19-3160-0	Looper holder	ルーバー台	1
66	71-9080-0	Looper holder tapered pin	ルーバー台テーパピン	1
67	86-4130-0	Nut	ナット	1
69	84-5710-0	Screw	ネジ	2
70	75-4010-0	Washer	ワッシャ	1
71	75-4040-0	Washer	ワッシャ	1
72	71-4310-0	Link pin	ダルマピン	1

From the library of Diamond Needle Co.

5. Root filter components (挿え揚げ機構)

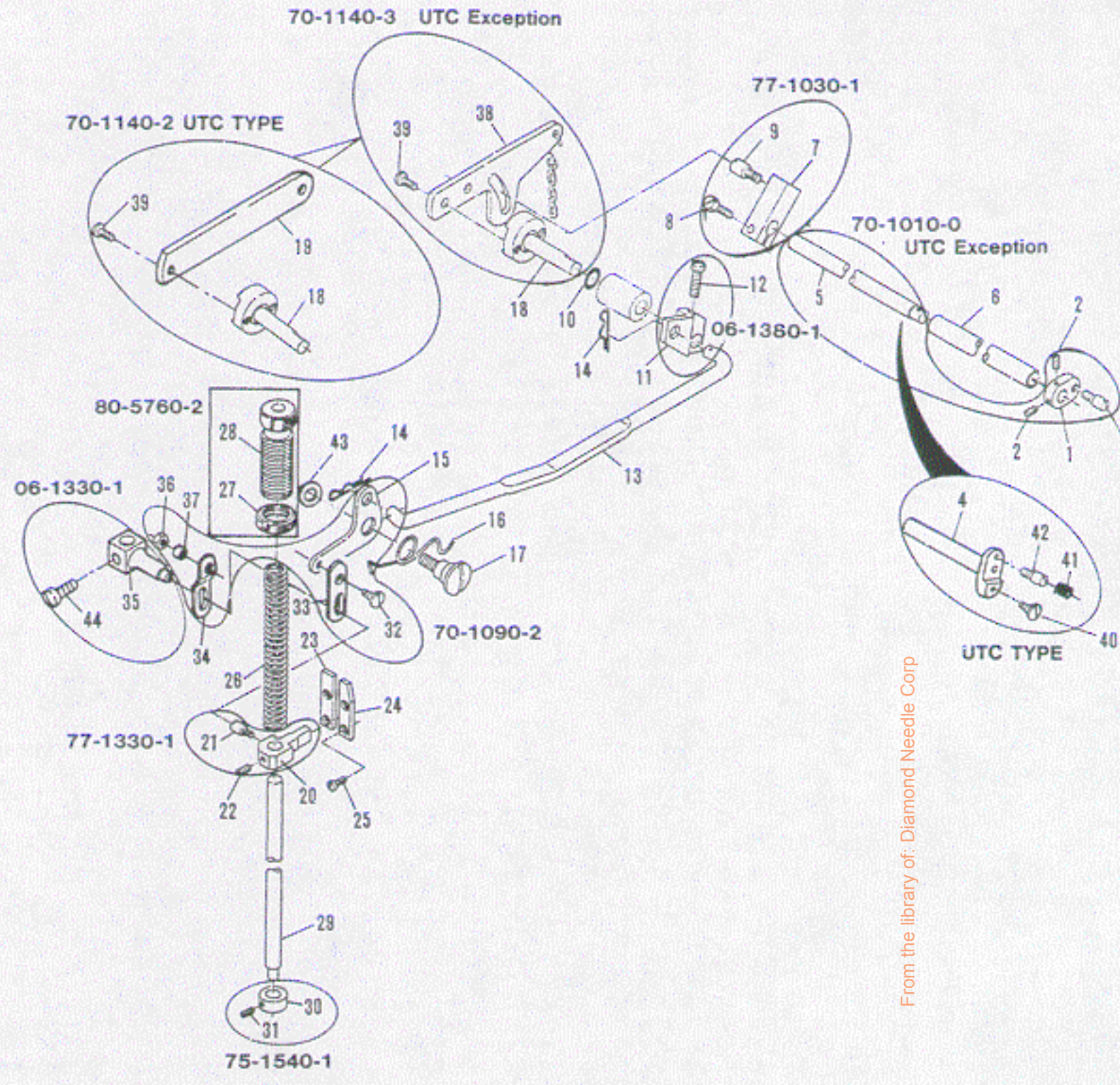

From the library of: Diamond Needle Corp

No.	Part No.	Part Name	品 名	Exception	UTCTYPE
1	77-1010-0	Lifter lever connecting	丸 駒	1	
2	84-5210-0	Screw	ネ ジ	1	
3	84-5620-0	Screw	ネ ジ	1	
4	06-9430-0	Tension release cam	糸ユルメカム		1
5	77-1110-0	Foot lifter crank shaft	押え上げクランクシャフト	1	
6	77-1210-0	Crank shaft pipe	クランクシャフトパイプ	1	1
7	77-1030-0	Ajusting post supporter	調子芯棒止メ板	1	1
8	84-8120-0	Screw	ネ ジ	1	1
9	84-5610-0	Screw	ネ ジ	1	1
10	23-1900-0	O-ring	Oリング	1	1
11	06-1380-0	Presser foot lifter connecting plate	押え上げ連結板	1	1
12	84-7640-0	Screw	ネ ジ	1	1
13	77-1160-0	Lifter lever connecting bar	押え上げ連結竿	1	1
14	93-6110-0	Snap pin A	スナップピン	2	2
15	77-1090-0	Lifter lever spring supporter	巻バネ止メ板	1	1
16	79-2220-0	Lifter lever spring	押え揚げ巻バネ	1	1
17	85-2010-0	Screw	段ネジ	1	1
18	06-1360-0	Lifter lever link	押え上げ土台芯棒	1	1
19	06-1310-0	Presser foot lifter lever	押え上げレバー		1
20	77-1330-0	Presser bar guide	押え棒抱き	1	1
21	84-5610-0	Screw	ネ ジ	1	1
22	84-5630-0	Screw	ネ ジ	1	1
23	77-0350-0	Presser bar connecting guide (left)	押え棒案内板左	1	1
24	77-0360-0	Presser bar connecting guide (right)	押え棒案内板右	1	1
25	84-5640-0	Screw	ネ ジ	4	4
26	79-1210-0	Presser bar spring	押え調節バネ	1	1
27	86-8510-0	Nut	押え棒筒ナット	1	1
28	85-7620-0	Presser bar screw	押え棒筒ネジ	1	1
29	71-5410-0	Presser bar (small)	押え棒 (小)	1	1
30	75-1540-1	Collar	押え棒用カラー	1	
31	84-5110-0	Screw	ネ ジ	1	
32	06-1350-0	Screw	押え上げリンク用ネジ	1	1
33	06-1320-0	Lifter lever guide link	押え上げガイドリンク	1	1
34	06-1390-0	Connecting plate for rear puller	連結板	1	1
35	06-1330-0	Presser bar guide for rear puller	押え揚げガイド	1	1
36	86-3120-0	Nut	ナット	1	1
37	06-1340-0	Collar	押え棒連結板用カラー	1	1
38	77-8110-0	Presser foot lifter lever	押え上げレバー	1	
39	84-5660-0	Screw	ネ ジ	2	1
40	84-7820-0	Screw	ネ ジ		1
41	79-1640-0	Spring	バ ネ		1
42	84-5610-0	Screw	ネ ジ		1
43	75-4530-0	Washer	ワッシャー	1	1
44	84-8140-0	Screw	ネ ジ	1	1

From the library of Diamond Needle Corp.

9. Puller (プーラー機構)

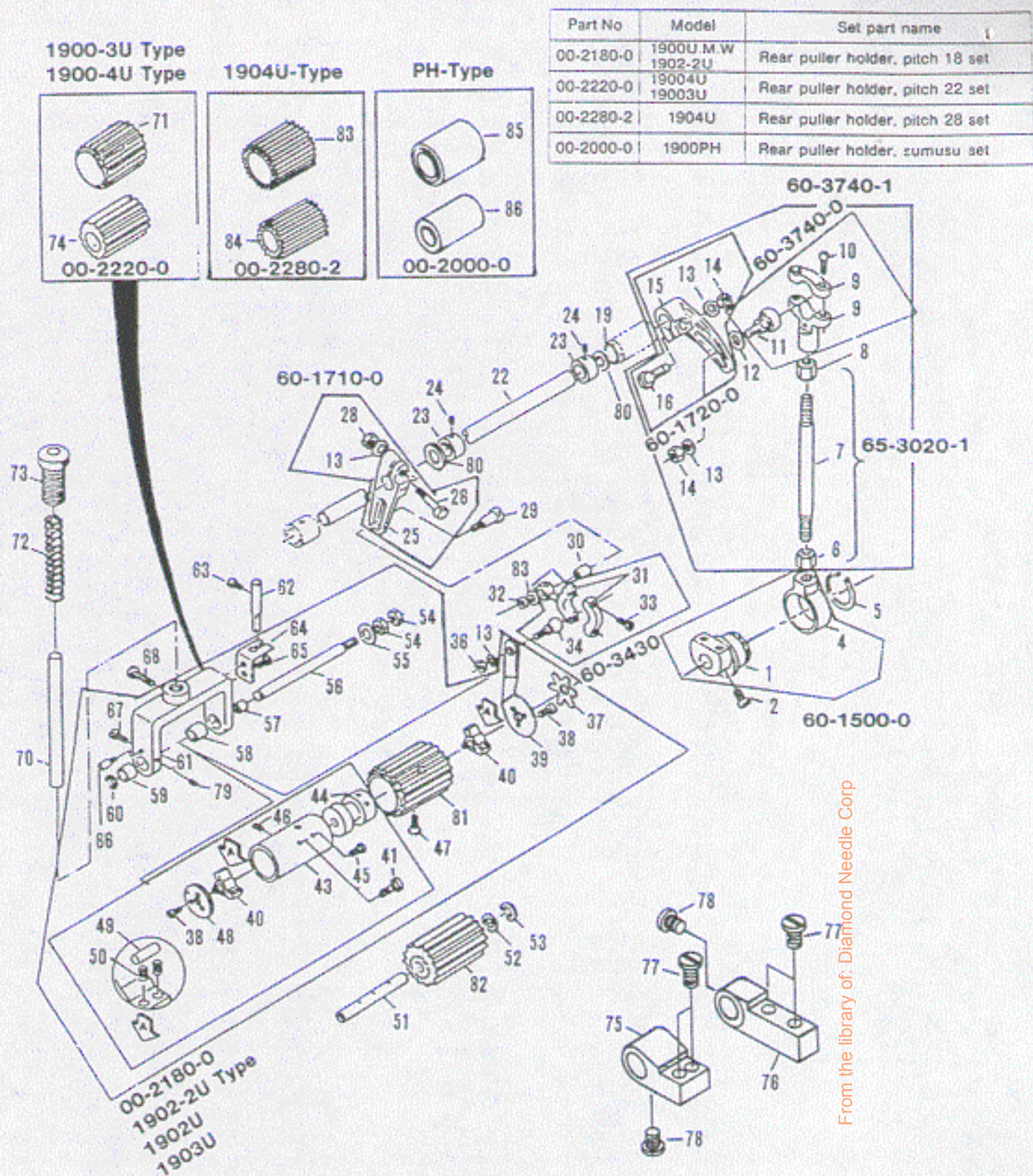

From the library of: Diamond Needle Corp

No.	Part No.	Part Name	品名	1903U 1902U 1902-2U	1900-3U 1900-4U	1904U
1	61-2010-U	Puller driving eccentric	連結エキセン玉	1	1	1
2	84-7620-0	Screw	ネジ	2	2	2
4	63-2010-U	Connecting link	上シャフト連結ダルマ	1	1	1
5	93-2510-0	25-Snap ring	25-スナップリング	1	1	1
6	86-7410-0	Nut	ナット	1	1	1
7	65-3020-0	Puller driving connecting bar	上シャフト連結棒	1	1	1
8	86-7420-0	Nut	ナット左	1	1	1
9	63-7110-1	Ball joint	立ロット小	1	1	1
10	84-5670-0	Screw	ネジ	2	2	2
11	61-7140-U	Connecting rod ball	上シャフト連結ロット玉	1	1	1
12	75-4910-0	Washer	ワッシャー	1	1	1
13	75-5520-0	Washer	M6平座全B	4	4	4

No.	Part No.	Part Name	品名	1902U	1900-3U	1904U
				1902-2U	1900-4U	
14	86-5010-0	Nut	ナット	2	2	2
15	67-1720-0	Puller driving lever (rear)	上シャフト連結レバー後	1	1	1
16	55-0610-0	Pin	送りレバー止めピン	1	1	1
19	23-1970-0	O-ring	Oリング	1	1	1
22	71-6910-0	Puller driving shaft A	上シャフト	1	1	1
23	75-1130-1	Drive shaft collar	上シャフトカラー大	2	2	2
24	84-7180-0	Screw	ネジ	4	4	4
25	67-1710-0	Puller driving lever (front)	上シャフト連結レバー前	1	1	1
26	85-1910-0	Screw	ネジ	1	1	1
28	86-5410-0	Nut	ナット	1	1	1
29	84-5840-0	Screw	ネジ	1	1	1
30	75-2470-0	Connecting link roller	連結メガネローラーB	1	1	1
31	63-8100-1	Puller connecting rod	プーラー連結ロッド	1	1	1
32	86-3120-0	Nut	ナット	1	1	1
33	84-5720-0	Screw	ネジ	2	2	2
34	61-8100-U	Connecting rod ball	プーラー連結ロッド玉	1	1	1
36	86-4110-0	Nut	ナット	1	1	1
37	79-5510-0	Puller plate spring	プーラー板バネ	1	1	1
38	84-1620-0	Screw	ネジ	6	6	6
39	02-2630-0	Rear puller connecting plate	後プーラー小用連結板	1	1	1
40	02-1010-0	Clutch A	プーラー巴A	2	2	2
41	84-7180-0	Screw	ネジ	1	1	1
43	02-1560-0	Rear puller pipe	後プーラーパイプ大	1	1	1
44	02-1610-0	Rear puller thrust collar	後プーラースラスト大	1	1	1
45	84-4620-0	Screw	ネジ	3	3	3
46	84-7190-0	Screw	ネジ	1	1	1
47	84-4620-0	Screw	ネジ	3	3	3
48	02-1170-0	Rear puller pipe cover	後プーラーパイプフタ	1	1	1
49	71-4660-0	Clutch roller	プーラー巴ローラー	6	6	6
50	79-1910-0	Clutch spring	プーラー巴バネ	12	12	12
51	71-6520-0	Rear puller shaft	後プーラーシャフト	1	1	1
52	75-3720-0	Washer	ルーバー台シャフトワッシャ小	1	1	1
53	02-1160-0	Spring washer	小ローラーシャフト用バネ	1	1	1
54	86-7610-0	Nut	ナット	2	2	2
55	75-4510-0	Washer	8.1-ワッシャ	1	1	1
56	71-4710-0	Rear puller shaft (upper)	後プーラー台シャフト大	1	1	1
57	81-3230-0	Puller holder shaft bushing S	プーラー台シャフトブッシュ小	1	1	1
58	81-3220-0	Puller holder shaft bushing M	プーラー台シャフトブッシュ中	1	1	1
59	81-3210-0	Puller holder shaft bushing L	プーラー台シャフトブッシュ大	1	1	1
60	93-2210-0	E-7 Stop ring	ストップリング E-7 (E型止め輪)	1	1	1
61	02-1510-0	Rear puller holder	後プーラー台大	1	1	1
62	71-9210-0	Puller guide pin	プーラー回り止め棒	1	1	1
63	84-6150-0	Screw	ネジ	1	1	1
64	02-1660-0	Rear puller guide bracket	後プーラー台用回り止め	1	1	1
65	84-6150-0	Screw	ネジ	2	2	2
66	84-5730-0	Screw	ネジ	1	1	1
67	84-5660-0	Screw	ネジ	1	1	1
68	84-8140-0	Screw	ネジ	1	1	1
70	71-6380-0	Ruller presser shaft	後プーラー立シャフト	1	1	1
71	02-1770-0	Rear puller gear, pitch22 (Nylon)	後プーラー22山 (ナイロン)		1	
72	79-1260-0	Puller spring	プーラー巻バネ	1	1	1
73	87-7510-0	Puller screw	ネジ	1	1	1
74	02-2070-0	Rear puller gear, pitch18 (Nylon)	後プーラー18山 (ナイロン)		1	
75	02-9020-0	Rear puller bracket (left)	下プーラーブラケット (左)	1	1	1
76	02-9010-0	Rear puller bracket (right)	下ローラーブラケット (右)	1	1	1
77	84-7610-0	Screw	ネジ	4	4	4
78	84-5610-0	Screw	ネジ	2	2	2
79	84-6120-0	Screw	ネジ	1	1	1
80	75-3320-0	Washer	メインシャフトワッシャ大	2	2	2
81	02-1760-0	Rear collar gear, pitch18 (Nylon)	後プーラー18山 (ナイロン)	1		
82	02-2060-0	Rear puller gear, pitch15 (Nylon)	後プーラー15山 (ナイロン)	1		
83	75-5520-0	Washer	M6平座金	1	1	1
84	02-1780-0	Rear collar gear, pitch28 (Nylon)	後プーラー上28山 (ナイロン)			1
85	02-2080-0	Rear collar gear, pitch23 (Nylon)	後プーラー下23山 (ナイロン)			1
86	02-1810-0	Rear puller (Rubber) PH-Type	後プーラー上ローラーPH-Type			
87	02-2410-0	Rear puller (Rubber) PH-Type	後プーラー下ローラー PH-Type			

From the library of: Diamond Needle Corp

10-1. Guide (ゴム案内機構) 1902-2U, 1902U, 1904U

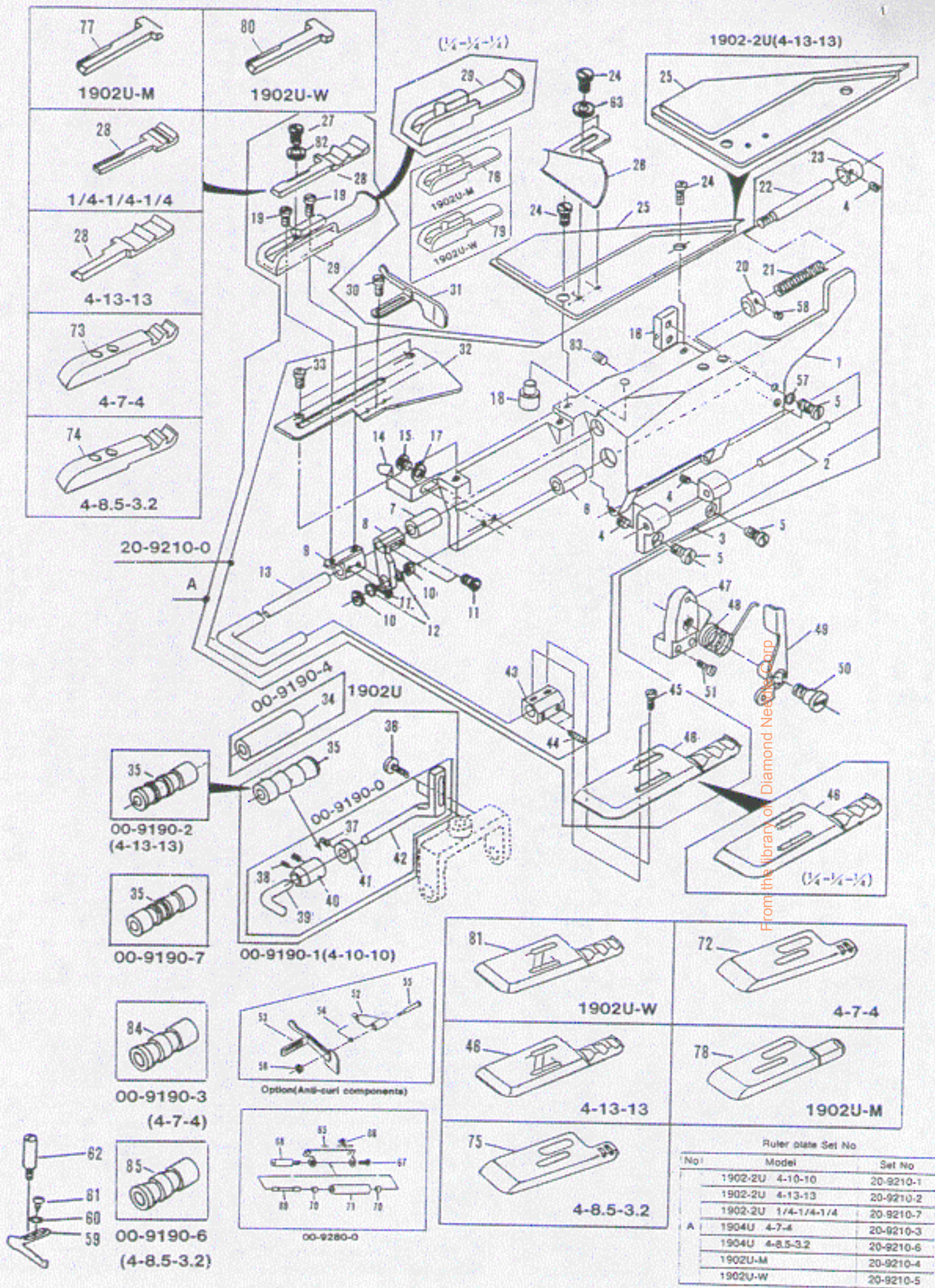

2	71-3100-0	Hinge pin for ruler holder	定規台ヒンジピン	1	1	1	1	1	1	1	1
3	25-1120-0	Hinge for ruler holder	定規台ヒンジ	1	1	1	1	1	1	1	1
4	84-3140-0	Screw	ネジ	3	3	3	3	3	3	3	3
5	84-5660-0	Screw	ネジ	4	4	4	4	4	4	4	4
6	81-9120-0	Rubber guide shaft bushing	ゴムガイドシャフトブッシュ	1	1	1	1	1	1	1	1
7	81-9110-0	Rubber guide shaft bushing	ゴムガイドシャフトブッシュ	1	1	1	1	1	1	1	1
8	09-9950-0	Connecting bracket	連結金具	1	1	1	1	1	1	1	1
9	09-9540-0	Slide metal for rubber guide	ゴム案内スライド金具	1	1	1	1	1	1	1	1
10	86-4110-0	Nut	ナット	2	2	2	2	2	2	2	2
11	84-6160-0	Screw	ネジ	4	4	4	4	4	4	4	4
12	75-4520-0	Washer	ワッシャ	2	2	2	2	2	2	2	2
13	09-9570-0	Slide bar for rubber guide bar	ゴムガイド棒スライドバー	1	1	1	1	1	1	1	1
14	79-5100-0	Fixing spring for ruler holder	定規台止バネ	1	1	1	1	1	1	1	1
15	84-3610-0	Screw	ネジ	2	2	2	2	2	2	2	2
16	09-9970-0	Elastic guide bracket	ゴム案内軸ブラケット	1	1	1	1	1	1	1	1
17	75-4550-0	Washer	ワッシャ	2	2	2	2	2	2	2	2
18	71-9560-0	Pin	定規台止メピン	1	1	1	1	1	1	1	1
19	84-3740-0	Screw	ネジ	2	2	2	2	2	2	2	2
20	75-1050-1	Rubber guide collar	カラー	1	1	1	1	1	1	1	1
21	79-2340-0	Spring	ゴムガイド戻しバネ	1	1	1	1	1	1	1	1
22	09-9960-0	Elastic guide rod	ゴム案内棒	1	1	1	1	1	1	1	1
23	09-1590-0	Elastic guide push	ゴムガイドプッシュ金具	1	1	1	1	1	1	1	1
24	84-5710-0	Screw	ネジ	4	4	4	4	4	4	4	4
25	21-9210-0	Ruler plate	定規台 (4-10-10, 1/4-1/4-1/4)	1	1	1	1	1	1	1	1
	21-9520-0	Ruler plate	定規台 (4-13-13)	1	1	1	1	1	1	1	1
26	09-9860-0	Guide right	右身頃ガイド	1	1	1	1	1	1	1	1
27	84-5640-0	Screw	ネジ	1	1	1	1	1	1	1	1
28	09-9820-0	Sub guide (4-10-10)	補助ゴムガイド (4-10-10)	1	1	1	1	1	1	1	1
	09-9520-0	Sub guide (4-13-13)	補助ゴムガイド (4-13-13)	1	1	1	1	1	1	1	1
	09-8820-0	Sub guide (1/4-1/4-1/4)	補助ゴムガイド (1/4-1/4-1/4)	1	1	1	1	1	1	1	1
29	09-9580-0	Slide base for rubber guide	ゴムガイドスライドベース	1	1	1	1	1	1	1	1
	09-8850-0	Slide base for rubber guide	ゴムガイドスライドベース	1	1	1	1	1	1	1	1
30	84-3910-0	Screw	ネジ	1	1	1	1	1	1	1	1
31	09-9510-0	Guide	生地ガイド	1	1	1	1	1	1	1	1
32	09-9530-0	Guide plate	ゴムガイドプレート	1	1	1	1	1	1	1	1
33	84-3620-0	Screw	ネジ	2	2	2	2	2	2	2	2
34	09-9190-0	Rubber guide for flat rubber (option)	平ゴム用履ローラー	(1)	(1)	(1)	(1)	(1)	(1)	(1)	(1)
	09-8840-0	Rubber guide for flat rubber (option)	平ゴム用履ローラー (別注)				(1)				
35	09-9050-0	Rubber guide for (4-10-10)	スライド式ゴムガイド (4-10-10)	1	1	1	1	1	1	1	1
	09-9060-0	Rubber guide for (4-13-13)	スライド式ゴムガイド (4-13-13)	1	1	1	1	1	1	1	1
	09-8830-0	Rubber guide for (1/4-1/4-1/4)	スライド式ゴムガイド (1/4均等)	1	1	1	1	1	1	1	1
36	84-3680-0	Screw	ネジ	1	1	1	1	1	1	1	1
37	84-5110-0	Screw	ネジ	1	1	1	1	1	1	1	1
38	84-7110-0	Screw	ネジ	4	4	4	4	4	4	4	4
39	09-9230-0	Rubber guide for puller	プーラーゴムガイド	1	1	1	1	1	1	1	1
40	09-9840-0	Rubber guide stopper	ゴムガイド止カラー	1	1	1	1	1	1	1	1
41	09-9170-0	Rubber guide collar	ゴムガイド止	1	1	1	1	1	1	1	1
42	09-9130-0	Rubber guide A for puller	プーラーゴムガイド	1	1	1	1	1	1	1	1
43	09-9850-0	Slide base for rubber guide	ゴムガイド取付金具	1	1	1	1	1	1	1	1
44	84-7180-0	Screw	ネジ	2	2	2	2	2	2	2	2
45	84-3700-0	Screw	ネジ	2	2	2	2	2	2	2	2
46	09-9830-0	Rubber guide holder (4-10-10)	ゴムガイドホルダー (4-10-10)	1	1	1	1	1	1	1	1
	09-9930-0	Rubber guide holder (4-13-13)	ゴムガイドホルダー (4-13-13)	1	1	1	1	1	1	1	1
	09-8810-0	Rubber guide holder (1/4-1/4-1/4)	ゴムガイドホルダー (1/4-1/4-1/4)	1	1	1	1	1	1	1	1
47	09-9980-0	Slide lever mounting bracket	ゴム案内レバーベース	1	1	1	1	1	1	1	1
48	79-2260-0	Spring	ゴム案内レバー巻バネ	1	1	1	1	1	1	1	1
49	09-9990-0	Slide lever	ゴム案内レバー	1	1	1	1	1	1	1	1
50	85-6710-0	Screw	ネジ	1	1	1	1	1	1	1	1
51	84-7630-0	Screw	ネジ	1	1	1	1	1	1	1	1
52	09-9460-0	Sliding elastic guide (option)	カール防止用生地ガイド (別注)	(1)	(1)	(1)	(1)	(1)	(1)	(1)	(1)
53	09-9470-0	Anti-curl plate (option)	カール防止板 (別注)	(1)	(1)	(1)	(1)	(1)	(1)	(1)	(1)
54	79-9160-0	Spring (option)	カール防止バネ (別注)	(1)	(1)	(1)	(1)	(1)	(1)	(1)	(1)
55	87-1140-0	Screw (option)	ネジ (別注)	(1)	(1)	(1)	(1)	(1)	(1)	(1)	(1)
56	06-0080-0	Nut (option)	板バネエキセン取付ナット (別注)	(1)	(1)	(1)	(1)	(1)	(1)	(1)	(1)
57	75-4530-0	Washer	ワッシャ	2	2	2	2	2	2	2	2
58	84-3140-0	Screw	ネジ	2	2	2	2	2	2	2	2
59	09-9780-0	Guide ruler A	ガイド定規 A	1	1	1	1	1	1	1	1
60	75-4530-0	Washer	ワッシャ	1	1	1	1	1	1	1	1
61	09-2860-0	Screw	ネジ	1	1	1	1	1	1	1	1
62	84-5610-0	Screw	ネジ	1	1	1	1	1	1	1	1
63	75-4560-0	Washer	ワッシャ	2	2	2	2	2	2	2	2
65	09-9730-0	Roller bracket	ローラーブラケット	1	1	1	1	1	1	1	1
66	84-3620-0	Screw	ネジ	2	2	2	2	2	2	2	2
67	84-3610-0	Screw	ネジ	1	1	1	1	1	1	1	1
68	09-9180-0	Roller (left)	ローラー (左)	1	1	1	1	1	1	1	1
69	71-9970-0	Shaft	シャフト	1	1	1	1	1	1	1	1
70	91-1110-0	Bearing	ベアリング	2	2	2	2	2	2	2	2
71	09-1230-0	Roller	ローラー	1	1	1	1	1	1	1	1
72	09-9890-0	Elastic guide holder (4-7-4)	ゴムガイドホルダー (4-7-4)	1	1	1	1	1	1	1	1
73	09-9900-0	Elastic guide slide base (4-7-4)	補助ゴムガイド (4-7-4)	1	1	1	1	1	1	1	1
74	09-8490-0	Elastic guide slide base (4-8.5-3.2)	補助ゴムガイド (4-8.5-3.2)	1	1	1	1	1	1	1	1
75	09-8500-0	Elastic guide holder (4-8.5-3.2)	ゴムガイドホルダー (4-8.5-3.2)	1	1	1	1	1	1	1	1
76	09-9740-0	Elastic guide slide base	ゴムガイドスライドベース	1	1	1	1	1	1	1	1
77	09-9810-0	Sub guide	補助ゴムガイド	1	1	1	1	1	1	1	1
78	09-9940-0	Elastic guide holder	ゴムガイドホルダー	1	1	1	1	1	1	1	1
79	09-9680-0	Slide base for rubber guide for flat rubber	ゴムガイドスライドベース	1	1	1	1	1	1	1	1
80	09-9810-0	Sub guide	補助ゴムガイド	1	1	1	1	1	1	1	1
81	09-9930-0	Rubber guide holder	ゴムガイドホルダー	1	1	1	1	1	1	1	1
82	75-4680-0	Washer	ワッシャ	1	1	1	1	1	1	1	1
83	84-3140-0	Screw	ネジ	1	1	1	1	1	1	1	1
84	09-9920-0	Rubber guide For (4-7-4)	ゴムガイドローラー	1	1	1	1	1	1	1	1
85	09-8510-0	Rubber guide For (4-8.5-3.2)	ゴムガイドローラー	1	1	1	1	1	1	1	1

10-2. Guide (ゴム案内機構) 1902-2U/UTC, 1902U/UTC, 1904U/UTC

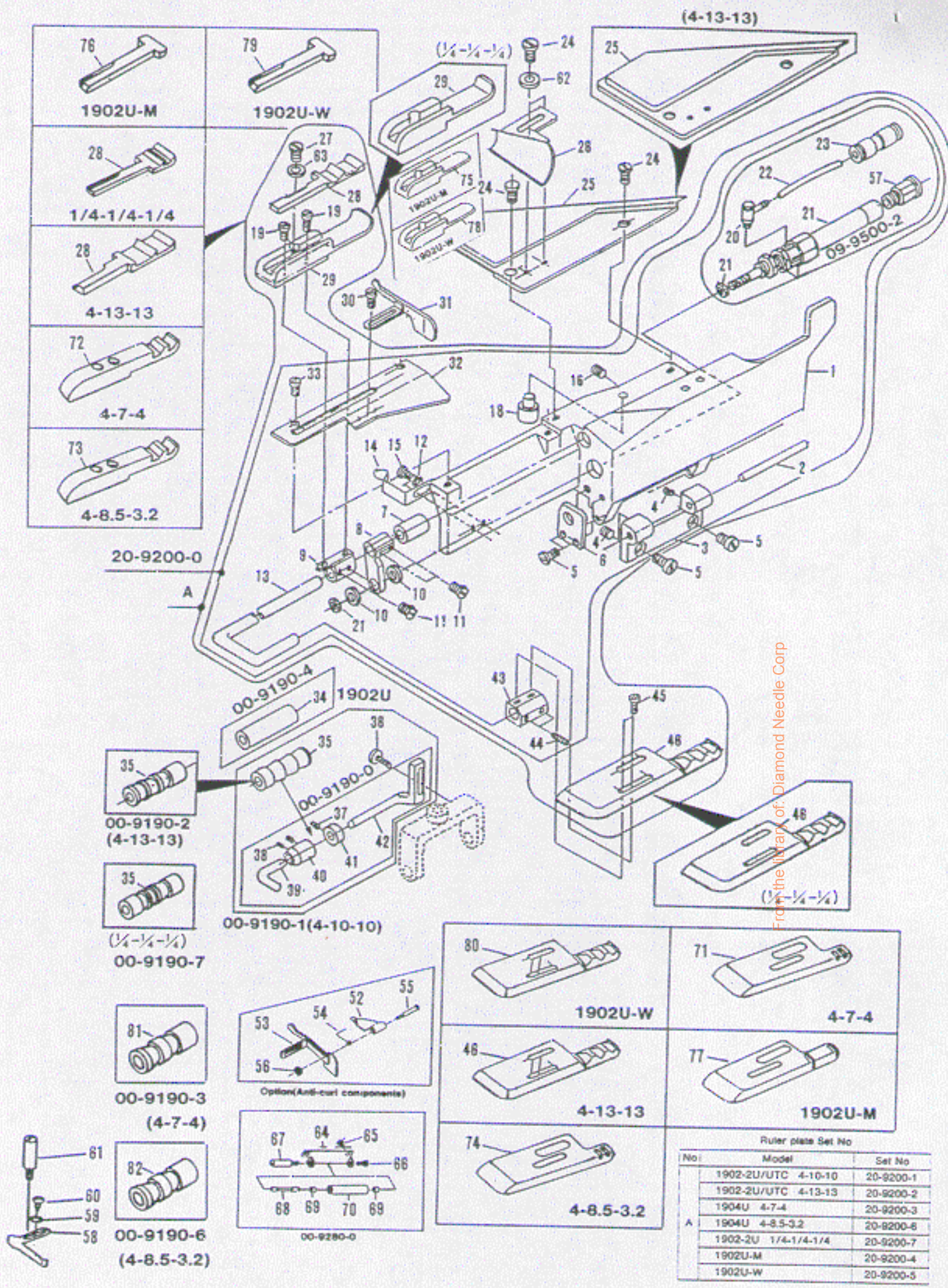

From the library of: Diamond Needle Corp

80	1902U-W	71	4-7-4
46	4-13-13	77	1902U-M
74	4-8.5-3.2		

Ruler plate Set No		
No.	Model	Set No
	1902-2U/UTC 4-10-10	20-9200-1
	1902-2U/UTC 4-13-13	20-9200-2
	1904U 4-7-4	20-9200-3
A	1904U 4-8.5-3.2	20-9200-6
	1902-2U 1/4-1/4-1/4	20-9200-7
	1902U-M	20-9200-4
	1902U-W	20-9200-5

1	21-9160-0	Ruler holder	定規台	1	1	1	1	1	1	1	1
2	71-3100-0	Hinge pin for ruler holder	定規台ヒンジピン	1	1	1	1	1	1	1	1
3	25-1120-0	Hinge for ruler holder	定規台ヒンジ	1	1	1	1	1	1	1	1
4	84-3140-0	Screw	ネジ	5	5	5	5	5	5	5	5
5	84-5660-0	Screw	ネジ	4	4	4	4	4	4	4	4
6	09-9650-0	Fixing metal for pen-cylinder	ペンシリンダー取付金具	1	1	1	1	1	1	1	1
7	81-9110-0	Rubber guide shaft bushing	ゴムガイドシャフトブッシュ	1	1	1	1	1	1	1	1
8	09-9610-0	Connecting bracket	連結金具	1	1	1	1	1	1	1	1
9	09-9540-0	Slide metal for rubber guide	ゴム案内スライド金具	1	1	1	1	1	1	1	1
10	75-4550-0	Washer	ワッシャ	2	2	2	2	2	2	2	2
11	84-6160-0	Screw	ネジ	4	4	4	4	4	4	4	4
12	75-4550-0	Washer	ワッシャ	2	2	2	2	2	2	2	2
13	09-9570-0	Slide bar for rubber guide bar	ゴムガイド棒スライドバー	1	1	1	1	1	1	1	1
14	79-5100-0	Fixing spring for ruler holder	定規台止バネ	1	1	1	1	1	1	1	1
15	84-3610-0	Screw	ネジ	2	2	2	2	2	2	2	2
16	84-3140-0	Screw	ネジ	1	1	1	1	1	1	1	1
18	71-9560-0	Pin	定規台止メピン	1	1	1	1	1	1	1	1
19	84-3140-0	Screw	ネジ	2	2	2	2	2	2	2	2
20	09-8600-0	Elbow-union	ユニバーサルエルボ	1	1	1	1	1	1	1	1
21	09-9500-0	Pen-cylinder	ペンシリンダー	1	1	1	1	1	1	1	1
22	09-8620-0	Air tube	エアチューブ	1	1	1	1	1	1	1	1
23	09-8610-0	Union	中間継平	1	1	1	1	1	1	1	1
24	84-5710-0	Screw	ネジ	4	4	4	4	4	4	4	4
25	21-9210-0	Ruler plate	定規台 (4-10-10,1/4-1/4-1/4)	1							
	21-9520-0	Ruler plate	定規台 (4-13-13)	1							
26	09-9860-0	Guide right	右身頃ガイド	1	1	1	1	1	1	1	1
27	84-5640-0	Screw	ネジ	1	1	1	1	1	1	1	1
28	09-9820-0	Sub guide (4-10-10)	補助ゴムガイド (4-10-10)	1							
	09-9520-0	Sub guide (4-13-13)	補助ゴムガイド (4-13-13)	1							
	09-8820-0	Sub guide (1/4-1/4-1/4)	補助ゴムガイド (1/4-1/4-1/4)	1							
29	09-9580-0	Slide base for rubber guide	ゴムガイドスライドベース	1	1						
	09-8850-0	Slide base for rubber guide	ゴムガイドスライドベース	1	1						
30	84-3910-0	Screw	ネジ	1	1	1	1	1	1	1	1
31	09-9510-0	Guide	生地ガイド	1	1	1	1	1	1	1	1
32	09-9530-0	Guide plate	ゴムガイドプレート	1	1	1	1	1	1	1	1
33	84-3620-0	Screw	ネジ	2	2	2	2	2	2	2	2
34	09-9190-0	Rubber guide for flat rubber (option)	平ゴム用後ローラー	(1)	(1)			(1)	(1)	1	1
	09-8840-0	Rubber guide for flat rubber (option)	平ゴム用後ローラー (別注)					(1)			
35	09-9050-0	Rubber guide for (4-10-10)	スライド式ゴムガイド (4-10-10)	1							
	09-9060-0	Rubber guide for (4-13-13)	スライド式ゴムガイド (4-13-13)	1							
	09-8830-0	Rubber guide for (1/4-1/4-1/4)	スライド式ゴムガイド (1/4均等)	1							
36	84-3680-0	Screw	ネジ	1	1	1	1	1	1	1	1
37	84-5110-0	Screw	ネジ	1	1	1	1	1	1	1	1
38	84-7110-0	Screw	ネジ	4	4	4	4	4	4	4	4
39	09-9230-0	Rubber guide for puller	プーラーゴムガイド	1	1	1	1	1	1	1	1
40	09-9840-0	Rubber guide stopper	ゴムガイド止カラー	1	1	1	1	1	1	1	1
41	09-9170-0	Rubber guide collar	ゴムガイド止	1	1	1	1	1	1	1	1
42	09-9130-0	Rubber guide A for puller	プーラーゴムガイド	1	1	1	1	1	1	1	1
43	09-9850-0	Slide base for rubber guide	ゴムガイド取付金具	1	1	1	1	1	1	1	1
44	84-7180-0	Screw	ネジ	2	2	2	2	2	2	2	2
45	84-3700-0	Screw	ネジ	2	2	2	2	2	2	2	2
46	09-9830-0	Rubber guide holder (4-10-10)	ゴムガイドホルダー (4-10-10)	1							
	09-9930-0	Rubber guide holder (4-13-13)	ゴムガイドホルダー (4-13-13)	1							
	09-8810-0	Rubber guide holder (1/4-1/4-1/4)	ゴムガイドホルダー (1/4-1/4-1/4)	1							
52	09-9460-0	Sliding elastic guide (option)	カール防止用生地ガイド (別注)	(1)	(1)	(1)	(1)	(1)	(1)	(1)	(1)
53	09-9470-0	Anti-curl plate (option)	カール防止板 (別注)	(1)	(1)	(1)	(1)	(1)	(1)	(1)	(1)
54	79-9160-0	Spring (option)	カール防止バネ (別注)	(1)	(1)	(1)	(1)	(1)	(1)	(1)	(1)
55	87-1140-0	Screw (option)	ネジ (別注)	(1)	(1)	(1)	(1)	(1)	(1)	(1)	(1)
56	06-0080-0	Nut (option)	板バネエキセン取付ナット (別注)	(1)	(1)	(1)	(1)	(1)	(1)	(1)	(1)
57	06-9480-0	Joint	ジョイント	1	1	1	1	1	1	1	1
58	09-9760-0	Guide ruler A	ガイド定規	1	1	1	1	1	1	1	1
59	75-4530-0	Washer	ワッシャ	1	1	1	1	1	1	1	1
60	09-2860-0	Screw	ネジ	1	1	1	1	1	1	1	1
61	84-5610-0	Screw	ネジ	1	1	1	1	1	1	1	1
62	75-4560-0	Washer	ワッシャ	2	2	2	2	2	2	2	2
63	75-4680-0	Washer	ワッシャ	1	1	1	1	1	1	1	1
64	09-9730-0	Roller bracket	ローラーブラケット	1	1	1	1	1	1	1	1
65	84-3620-0	Screw	ネジ	2	2	2	2	2	2	2	2
66	84-3610-0	Screw	ネジ	1	1	1	1	1	1	1	1
67	09-9180-0	Roller (left)	ローラー (左)	1	1	1	1	1	1	1	1
68	71-8970-0	Shaft	シャフト	1	1	1	1	1	1	1	1
69	91-1110-0	Bearing	ベアリング	2	2	2	2	2	2	2	2
70	09-1230-0	Roller	ローラー	1	1	1	1	1	1	1	1
71	09-9690-0	Elastic guide holder (4-7-4)	ゴムガイドホルダー (4-7-4)					1			
72	09-9900-0	Elastic guide slide base (4-7-4)	補助ゴムガイド (4-7-4)					1			
73	09-8490-0	Elastic guide slide base (4-8.5-3.2)	補助ゴムガイド (4-8.5-3.2)						1		
74	09-8500-0	Elastic guide holder (4-8.5-3.2)	ゴムガイドホルダー (4-8.5-3.2)						1		
75	09-9740-0	Elastic guide slide base	ゴムガイドスライドベース							1	
76	09-9810-0	Sub guide	補助ゴムガイド							1	
77	09-9940-0	Elastic guide holder	ゴムガイドホルダー								1
78	09-9680-0	Slide base for rubber guide for flat rubber	ゴムガイドスライドベース								1
79	09-9810-0	Sub guide	補助ゴムガイド								1
80	09-9930-0	Rubber guide holder	ゴムガイドホルダー								1
81	09-9920-0	Rubber guide For (4-7-4)	ゴムガイドローラー					1			
82	09-8510-0	Rubber guide For (4-8.5-3.2)	ゴムガイドローラー						1		

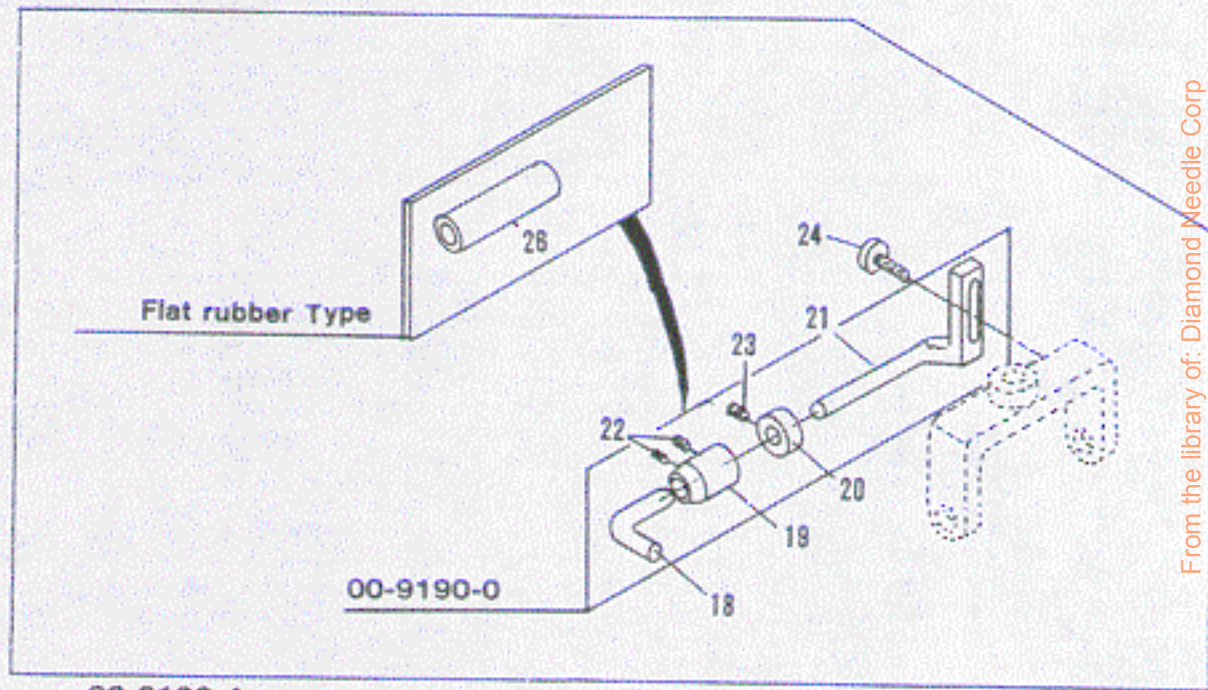
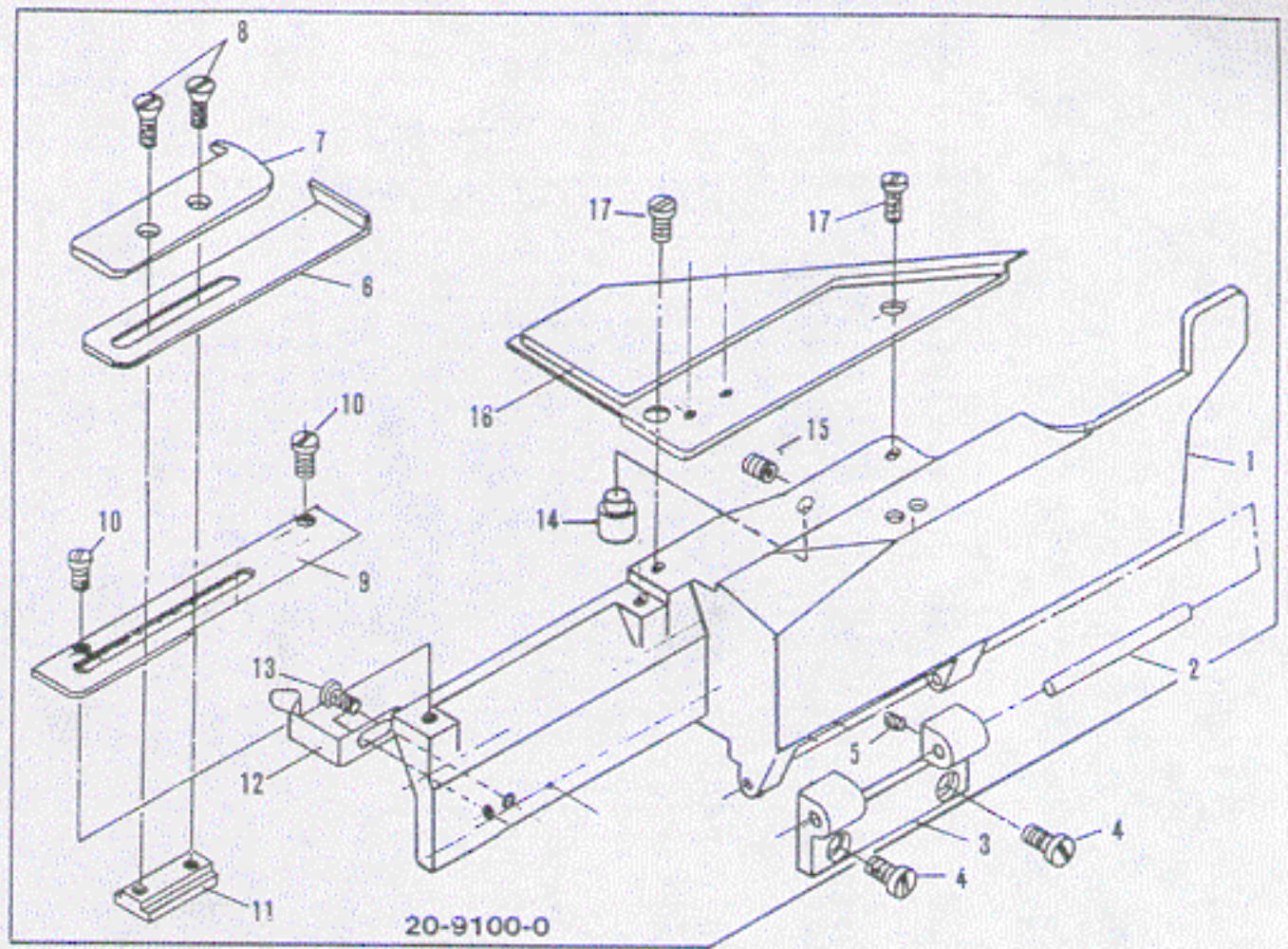

00-9190-4

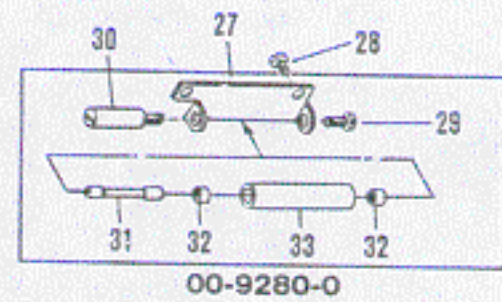
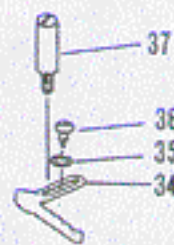

From the library of: Diamond Needle Corp

No.	Part No.	Part Name	品 名	Q. ty
1	21-9170-0	Ruler holder	定規台	1
2	71-3100-0	Hinge pin	定規台ヒンジピン	1
3	25-1120-0	Hinge	定規台ヒンジ	1
4	84-5660-0	Screw	ネジ	2
5	84-3140-0	Screw	ネジ	2
6	09-9770-0	Ruler guide (right)	ゴムガイド (右)	1
7	09-9780-0	Ruler guide (left)	ゴムガイド (左)	1
8	84-6640-0	Screw	ネジ	2
9	09-9790-0	Slide guide plate	ゴムガイドプレート	1
10	84-3620-0	Screw	ネジ	2
11	09-9800-0	Slide base	ゴムガイドスライドガイド	1
12	79-5100-0	Ruler holder spring	定規台止メバネ	1
13	84-3740-0	Screw	ネジ	2
14	71-9560-0	Pin	止メピン	1
15	84-3140-0	Screw	ネジ	1
16	21-9210-0	Ruler plate	定規板	1
17	84-5710-0	Screw	ネジ	2
18	09-9230-0	Puller elastic guide (B)	プーラーゴムガイド (B)	1
19	09-9840-0	Elastic guide stopper (A)	ゴムガイド止メ (A)	1
20	09-9170-0	Elastic guide stopper (B)	ゴムガイド止メ (B)	1
21	09-9130-0	Puller elastic guide (A)	プーラーゴムガイド (A)	1
22	84-7110-0	Screw	ネジ	4
23	84-5110-0	Screw	ネジ	1
24	84-3680-0	Screw	ネジ	2
26	09-9190-0	Rear roller (for flat rubber)	平ゴム用後ローラ	1
27	09-9730-0	Roller bracket	ローラブラケット	1
28	84-3620-0	Screw	ネジ	2
29	84-3610-0	Screw	ネジ	1
30	09-9180-0	Roller (left)	ローラ (左)	1
31	71-9970-0	Shaft	シャフト	1
32	91-1110-0	Bearing	ベアリング	2
33	09-1230-0	Roller	ローラ	1
34	09-9760-0	Guide ruler A	ガイド定規 A	1
35	75-4530-0	Washer	ワッシャ	1
36	09-2860-0	Screw	ネジ	1
37	84-5610-0	Screw	ネジ	1

From the library of Diamond Needle Corp

00-9020-0

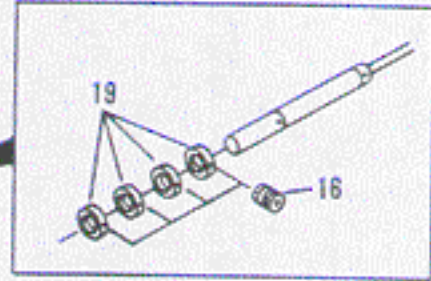
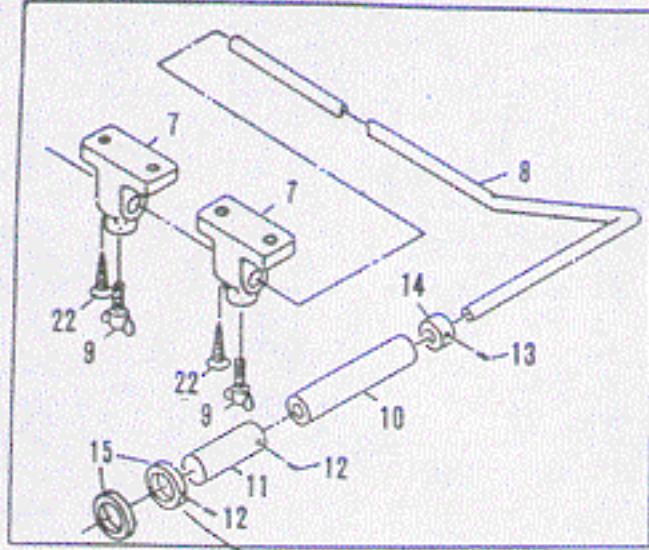

1902-2U/UTC
1902-2U
1904U/UTC
1904U

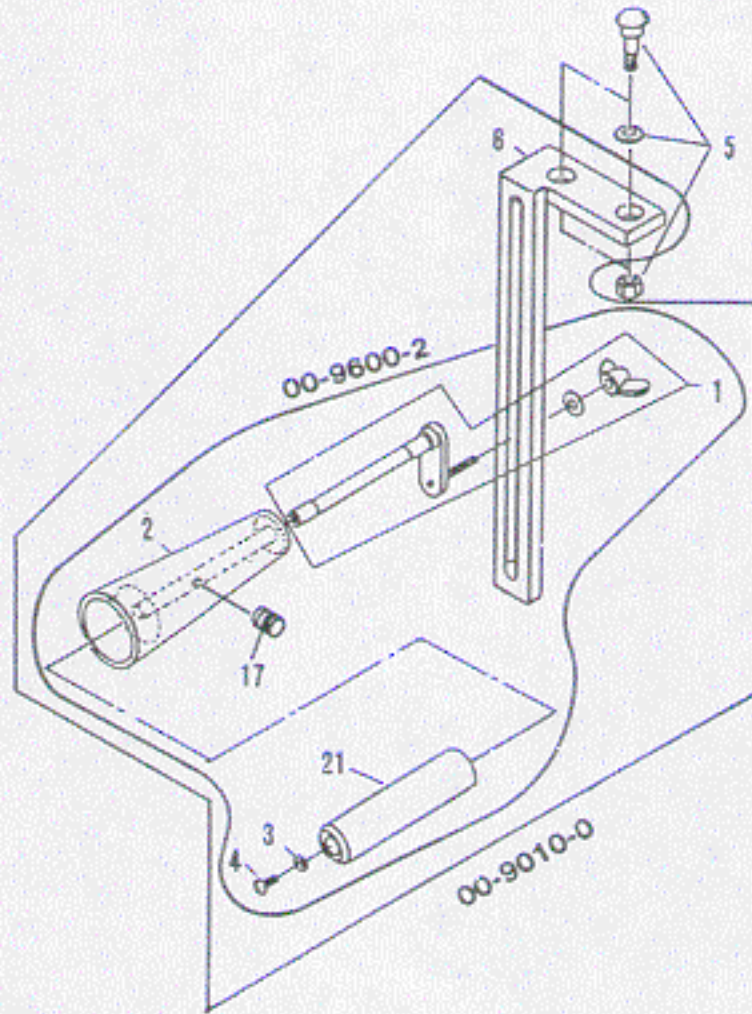

From the library of: Diamond Needle Corp

No.	Part No.	Part Name	品名	Q. ty
1	09-7260-0	Roller bearing	リヤローラー調節軸	1
2	09-7240-0	Roller	テーバローラ	1
3	75-5520-0	Washer	座金	3
4	84-7620-0	Screw	ネジ	1
5	80-7510-0	Mounting volt	クラッチモーター取付ネジ	2
6	09-1360-0	Tension bracket (large)	テンションブラケット (大)	1
7	09-1420-0	Roller bracket	ローラブラケット	2
8	09-1410-0	Roller bracket bar	ローラブラケットバー	1
9	09-1460-0	Screw	ブラケットバー止メネジ	2
10	09-1440-0	Roller (medium)	ローラ (中)	1
11	09-1430-0	Collar (large)	エンドカラー (大)	1
12	84-5210-0	Screw (19004U)	ネジ (19004U)	3
13	84-5210-0	Screw	ネジ	1
14	09-1450-0	Collar (small)	エンドカラー (小)	1
15	09-1470-0	Rubber guide collar (19004U)	ゴムガイドカラー (19004U)	2
16	84-5110-0	Screw (1902-2U)	ネジ (1902-2U)	4
17	84-3120-0	Screw	ネジ	2
19	09-1470-0	Rubber guide collar (1902-2U)	ゴムガイドカラー (1902-2U)	4
21	09-7250-0	Rear roller	リヤローラ	1
22	87-9010-0	Screw	ネジ	4

Knife set No	
06-1030-1	1" Knife set
06-1040-1	1 1/4" Knife set
06-1050-1	3/4" Knife set

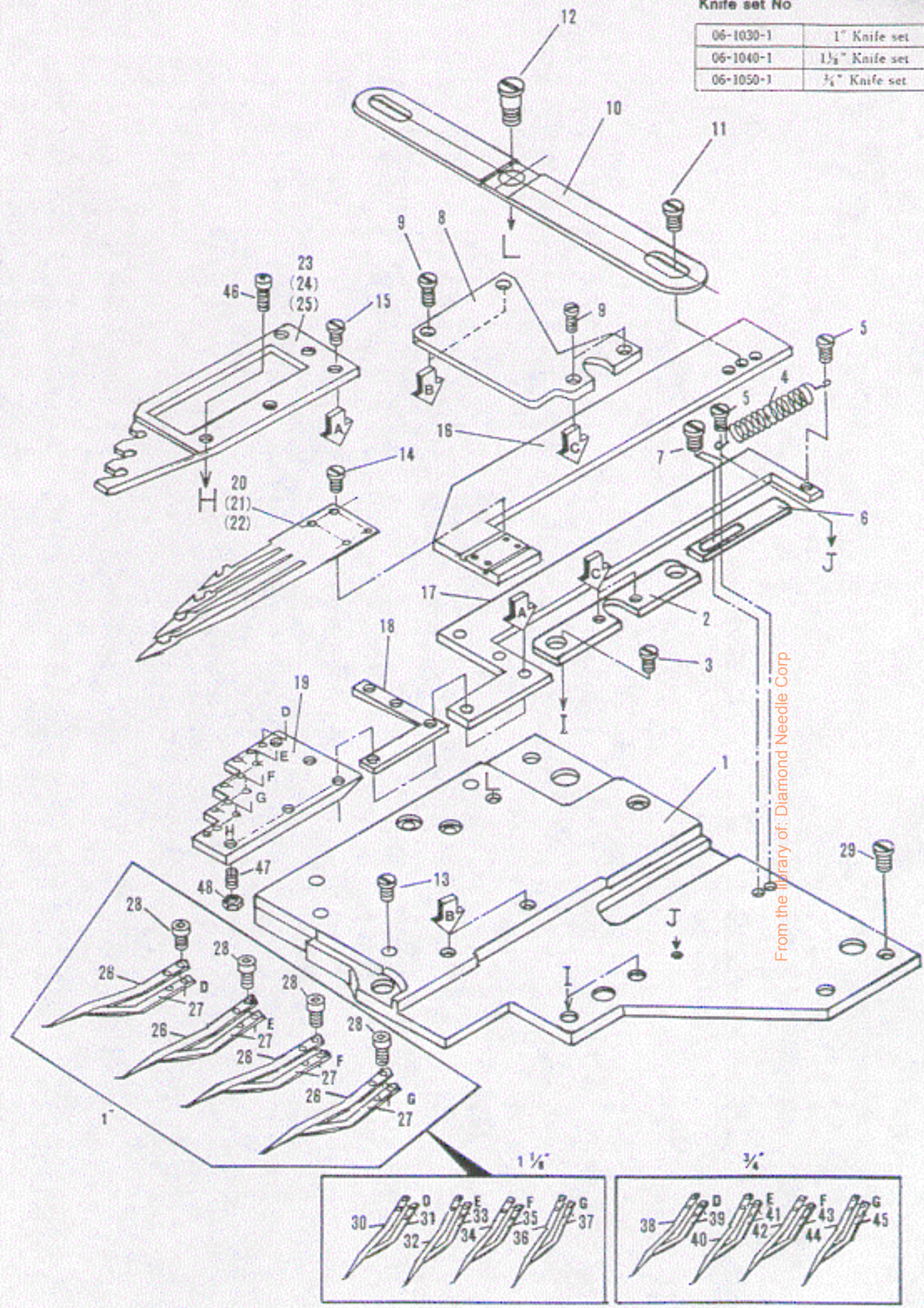

No.	Part No.	Part Name	品名	1904U/ UTC1"	1904U/ UTC1 1/4"	1904U/ UTC1 1/2"
1	06-0310-0	Base plate	ベースプレート	1	1	1
2	06-0330-0	Movable knife plate holder guide	メスガイドB	1	1	1
3	84-3610-0	Screw	ネジ	2	2	2
4	06-0460-0	Spring	固定メス引きバネ	1	1	1
5	85-6220-0	Screw	ネジ	2	2	2
6	06-0350-0	Fixed knife adjusting plate	固定メスアジャスター	1	1	1
7	84-1610-0	Screw	ネジ	2	2	2
8	06-0340-0	Knife holder cover	メス押えカバー	1	1	1
9	85-6220-0	Screw	ネジ	4	4	4
10	06-0360-0	Movable knife drive lever	回転レバー	1	1	1
11	84-2020-0	Screw	ネジ	1	1	1
12	84-9010-0	Screw	ネジ	1	1	1
13	84-5740-0	Screw	ネジ	4	4	4
14	06-0010-0	Screw	ネジ	4	4	4
15	06-0020-0	Screw	ネジ	4	4	4
16	06-8010-0	Movable blade base	可動メスベース	1	1	1
17	06-8020-0	Fixed knife base	固定メスベース	1	1	1
18	06-8050-0	Liner	上メスライナー	1	1	1
19	06-8040-0	Base plate for movable knife	バネベース	1	1	1
20	06-8830-0	Movable knife (1")	可動メス (1")	1		
21	06-8220-0	Movable knife (1 1/8")	可動メス (1 1/8")		1	
22	06-7820-0	Movable knife (3/4")	可動メス (3/4")			1
23	06-8030-0	Fixed knife (1")	固定メス (1")	1		
24	06-8210-0	Fixed knife (1 1/8")	固定メス (1 1/8")		1	
25	06-7810-0	Fixed knife (3/4")	固定メス (3/4")			1
26	06-8060-0	Plate spring (upper)(1")	メス裏バネ (上)	4		
27	06-8070-0	Plate spring (lower)(1")	メス裏バネ (下)	4		
28	06-0030-0	Screw	ネジ	8	8	8
29	84-5660-0	Screw	ネジ	5	5	5
30	06-8120-0	Plate spring (upper) 1 1/8"	メス裏バネ (上)1 1/8"		1	
31	06-8320-0	Plate spring (lower) 1 1/8"	メス裏バネ (下)1 1/8"		1	
32	06-8130-0	Plate spring (upper) 1 1/8"	メス裏バネ (上)1 1/8"		1	
33	06-8330-0	Plate spring (lower) 1 1/8"	メス裏バネ (下)1 1/8"		1	
34	06-8140-0	Plate spring (upper) 1 1/8"	メス裏バネ (上)1 1/8"		1	
35	06-8340-0	Plate spring (lower) 1 1/8"	メス裏バネ (下)1 1/8"		1	
36	06-8150-0	Plate spring (upper) 1 1/8"	メス裏バネ (上)1 1/8"		1	
37	06-8350-0	Plate spring (lower) 1 1/8"	メス裏バネ (下)1 1/8"		1	
38	06-8160-0	Plate spring (upper) 3/4"	メス裏バネ (上) 3/4"			1
39	06-8360-0	Plate spring (lower) 3/4"	メス裏バネ (下) 3/4"			1
40	06-8170-0	Plate spring (upper) 3/4"	メス裏バネ (上) 3/4"			1
41	06-8370-0	Plate spring (lower) 3/4"	メス裏バネ (下) 3/4"			1
42	06-8180-0	Plate spring (upper) 3/4"	メス裏バネ (上) 3/4"			1
43	06-8380-0	Plate spring (lower) 3/4"	メス裏バネ (下) 3/4"			1
44	06-8190-0	Plate spring (upper) 3/4"	メス裏バネ (上) 3/4"			1
45	06-8390-0	Plate spring (lower) 3/4"	メス裏バネ (下) 3/4"			1
46	06-0150-0	Screw	ネジ	1	1	1
47	06-0490-0	Spring	バネ	1	1	1
48	06-0200-0	Nut	ナット	1	1	1

From the library of: Diamond Needle Corp

1902-2U	4-10-10	06-1010-1
1902-2U	4-13-13	06-1020-1
1902-2U	1/4-1/4-1/4	06-1070-1
1902W	Wide	00-6200-0
1902M	Medium	00-6900-1
1904U	4-7-4	06-1060-1
1904U	4-8.5-3.2	06-1060-1
19003U	13-13	06-1080-1

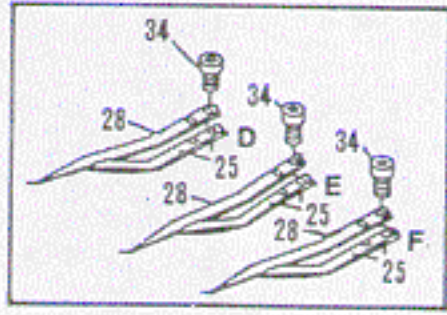
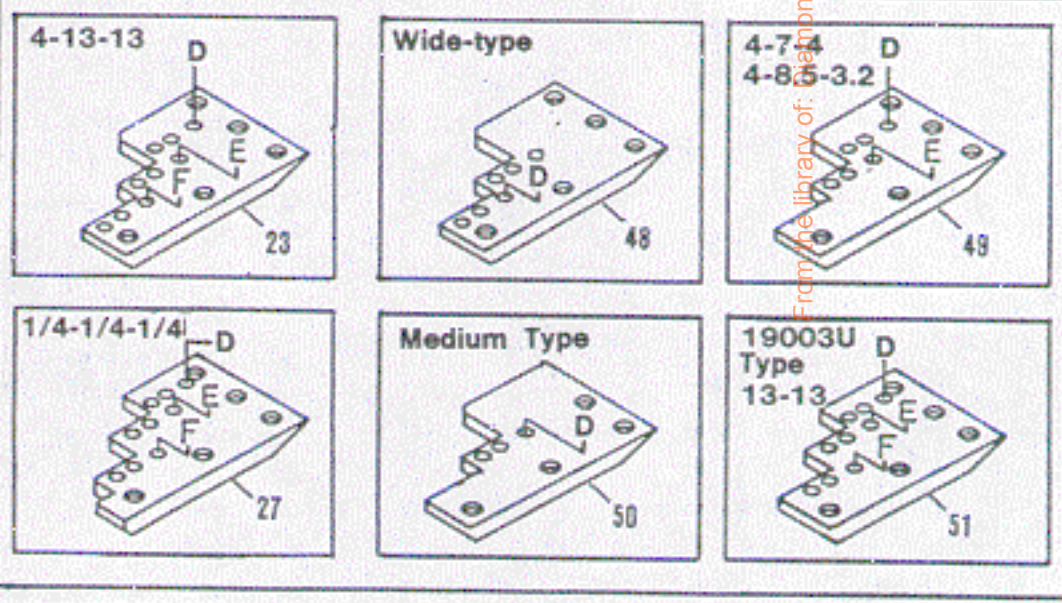
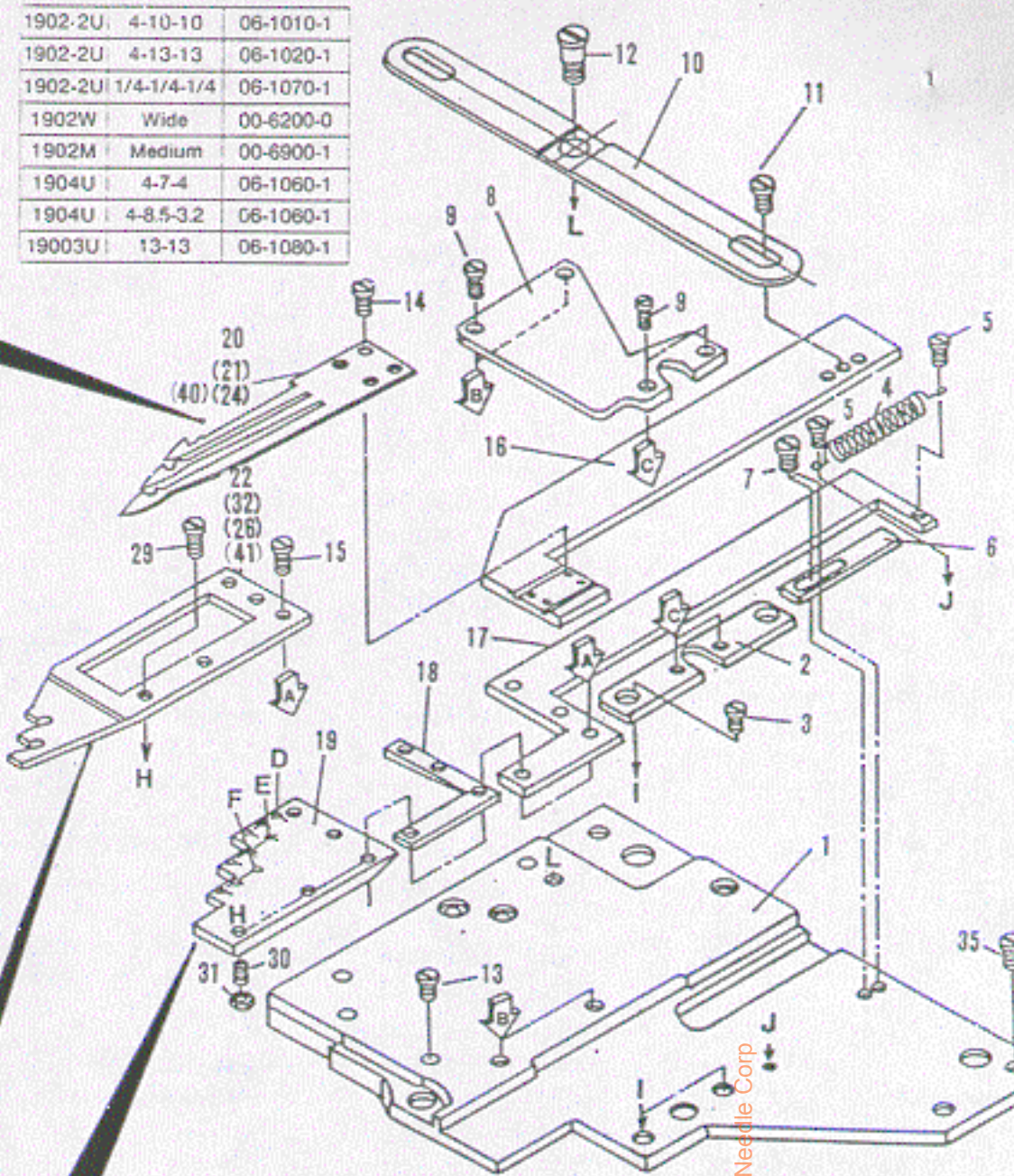
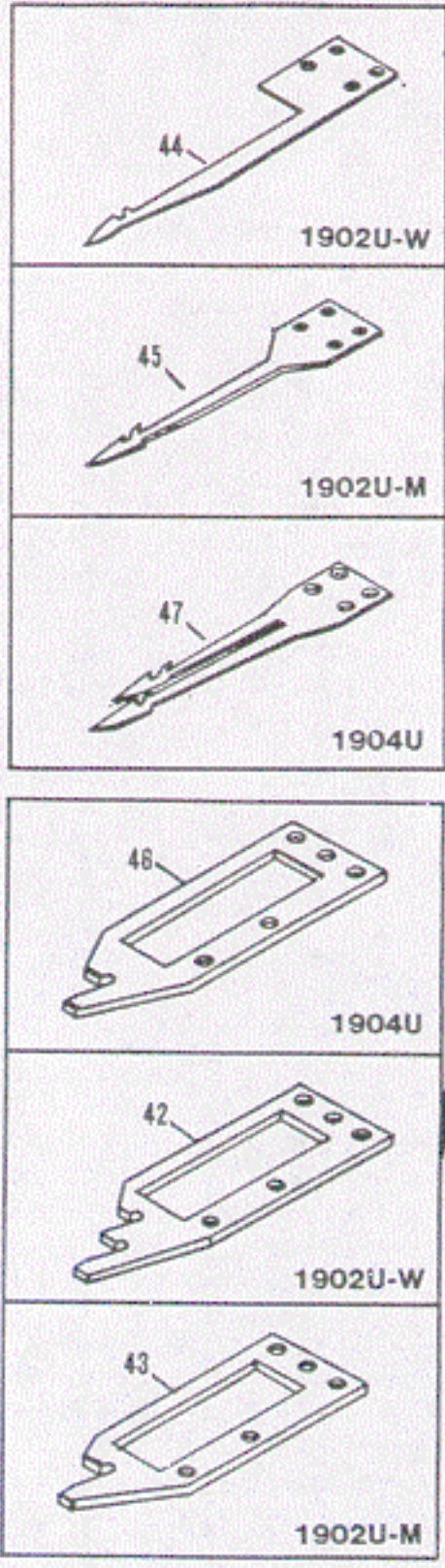

19003U
1902-2U Type 35

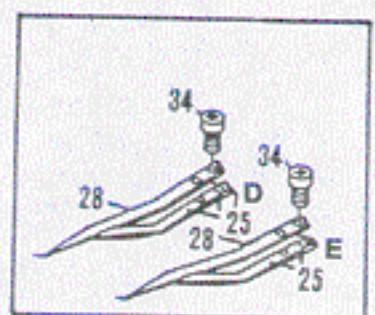

1904U-Type

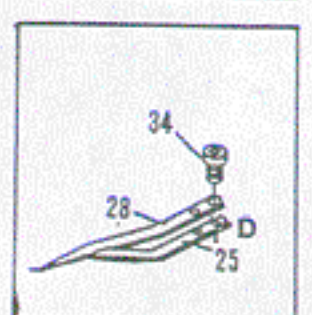

1902U
1903U Type(Wide)

From the library of: Diamond Needle Corp

No.	Part No.	Part Name	品名	4-13-13	4-10-10	1902U/ UTC Wide	1902U/ UTC 巾狭	1904U	19003U
1	06-0310-0	Base plate	ベースプレート	1	1	1	1	1	1
2	06-0330-0	Movable knife plate holder guide	メスガイドB	1	1	1	1	1	1
3	84-3610-0	Screw	ネジ	2	2	2	2	2	2
4	06-0460-0	Spring	固定メス引きバネ	1	1	1	1	1	1
5	85-6220-0	Screw	ネジ	2	2	2	2	2	2
6	06-0350-0	Fixed knife adjusting plate	固定メスアジャスター	1	1	1	1	1	1
7	84-1610-0	Screw	ネジ	2	2	2	2	2	2
8	06-0340-0	Knife holder cover	メス押えカバー	1	1	1	1	1	1
9	85-6220-0	Screw	ネジ	4	4	4	4	4	4
10	06-0360-0	Movable knife drive lever	回転レバー	1	1	1	1	1	1
11	84-2020-0	Screw	ネジ	1	1	1	1	1	1
12	84-9010-0	Screw	回転レバー取付ネジ	1	1	1	1	1	1
13	84-5740-0	Screw	ネジ	4	4	4	4	4	4
14	06-0010-0	Screw	ネジ	4	4	4	4	4	4
15	06-0020-0	Screw	ネジ	4	4	4	4	4	4
16	06-0400-0	Movable blade base	可動メスベース	1	1	1	1	1	1
17	06-0380-0	Fixed knife base	固定メスベース	1	1	1	1	1	1
18	06-0390-0	Liner	上メスライナー	1	1	1	1	1	1
19	06-9690-0	Base plate for movable knife	バネベース		1				
20	06-8510-0	Movable knife (4-13-13)	可動メス (4-13-13)	1					
21	06-0420-0	Movable knife (4-10-10)	可動メス (4-10-10)		1				
22	06-9670-0	Fixed knife	固定メス	1					
23	06-9700-0	Base plate for movable knife (4-13-13)	バネベース (4-13-13)	1		1			
24	06-9720-0	Movable knife (1/4-3/4-1/4)	可動メス (1/4-3/4-1/4)				1		
25	06-8340-0	Plate spring (weak) C	メスウラボネ(下) C	3	3	1	3	1	2 3
26	06-9730-0	Fixed knife	固定メス				1		
27	06-9740-0	Base plate for movable knife (1/4-3/4-1/4)	バネベース (1/4-3/4-1/4)				1		
28	06-8140-0	Plate spring (strong) C	メスウラボネ(上) C	3	3	1	3	1	2 3
29	06-0150-0	Screw	ネジ	1	1	1	1	1	1
30	06-0490-0	Spring	バネ	1	1	1	1	1	1
31	06-0200-0	Nut	ナット	1	1	1	1	1	1
32	06-9660-0	Fixed knife	固定メス		1				
33	06-0580-0	Movable knife 1902U/UTC	可動メス 1902U/UTC			1			
34	06-0030-0	Screw	ネジ	6	6	2	6	2	4 6
35	84-5660-0	Screw	ネジ	5	5	5	5	5	5
36	06-9700-0	Base plate for movable knife (wide)	バネベース (巾広)						
37	06-9710-0	Base plate for movable knife (巾狭)	バネベース (巾狭)				1		
38	06-9650-0	Base plate for movable knife (1904U)	バネベース (1904U)					1	
39	06-9920-0	Base plate for movable knife (13-13)	バネベース (13-13)						1
40	06-9720-0 06-990	Movable knife (13-13)	可動メス (13-13)						1
41	06-9910-0	Fixed knife (13-13)	固定メス (13-13)						1
42	06-9670-0	Fixed knife (wide)	固定メス (巾広)			1			
43	06-9680-0	Fixed knife (巾狭)	固定メス (巾狭)				1		
44	06-0580-0	Movable knife (wide)	可動メス (巾広)			1			
45	06-8560-0	Movable knife (巾狭)	可動メス (巾狭)						
46	06-9640-0	Fixed knife (1904U)	固定メス (1904U)						1
47	06-9630-0	Movable knife (1904U)	可動メス (1904U)						1
48	06-9700-0	Base plate for movable knife (wide)	バネベース			1			
49	06-9650-0	Base plate for movable knife	バネベース						
50	06-9710-0	Base plate for movable knife (巾狭)	バネベース				1		
51	06-9920-0	Base plate for movable knife (19003U)	バネベース						1

From the library of: Diamond Needle Corp

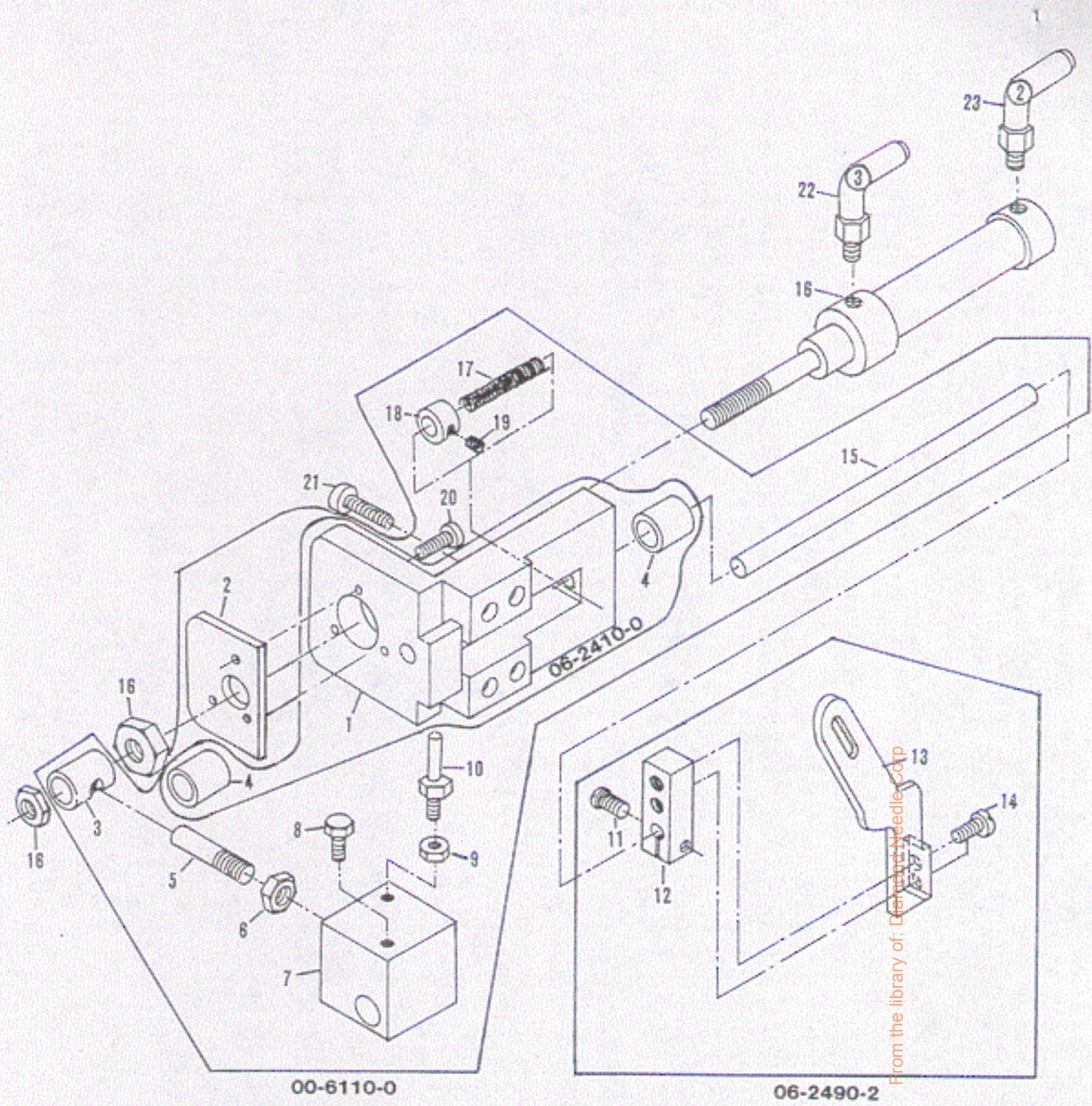

No.	Part No.	Part Name	品名	Q, ty
1	06-2410-0	Air cylinder mounting bracket	シリンダー取付ブラケット	1
2	06-2420-0	Air cylinder bracket	シリンダー取付プレート	1
3	06-2440-0	Thread cutter drive rod end	シリンダーロッドエンド	1
4	06-2480-0	Bush	ブッシュ	2
5	06-2460-0	Thread cutter drive connecting rod	シリンダー連結棒	1
6	86-7610-0	Nut	ナット	1
7	06-2430-0	Thread cutter drive connecting bracket	シリンダー連結ブラケット	1
8	84-8120-0	Screw	ネジ	1
9	86-7620-0	Nut	ナット	1
10	06-2450-0	Thread cutter drive connecting bar	回転レバー連結棒	1
11	84-8120-0	Screw	ネジ	1
12	06-2500-0	Thread tension connecting bracket	テンション連結止メ具	1
13	06-2490-0	Thread tension connecting plate	テンションホルダー連結板	1
14	84-5660-0	Screw	ネジ	2
15	06-2470-0	Cylinder guide rod	シリンダーガイドバー	1
16	06-2710-0	Air cylinder	エアシリンダー	1
17	06-2530-0	Spring	スプリング	1
18	75-1540-1	Collar	押え棒用カラー	1
19	84-5110-0	Screw	ネジ	1
20	84-7120-0 54-7765	Screw	ネジ	3
21	84-7650-0	Screw	ネジ	4
22	06-5190-3	L-type joint	L形継手 GL-4-6	1
23	06-5190-2	L-type joint	L形継手 GL-4-6	1

From the library of: Diamond Needle Corp

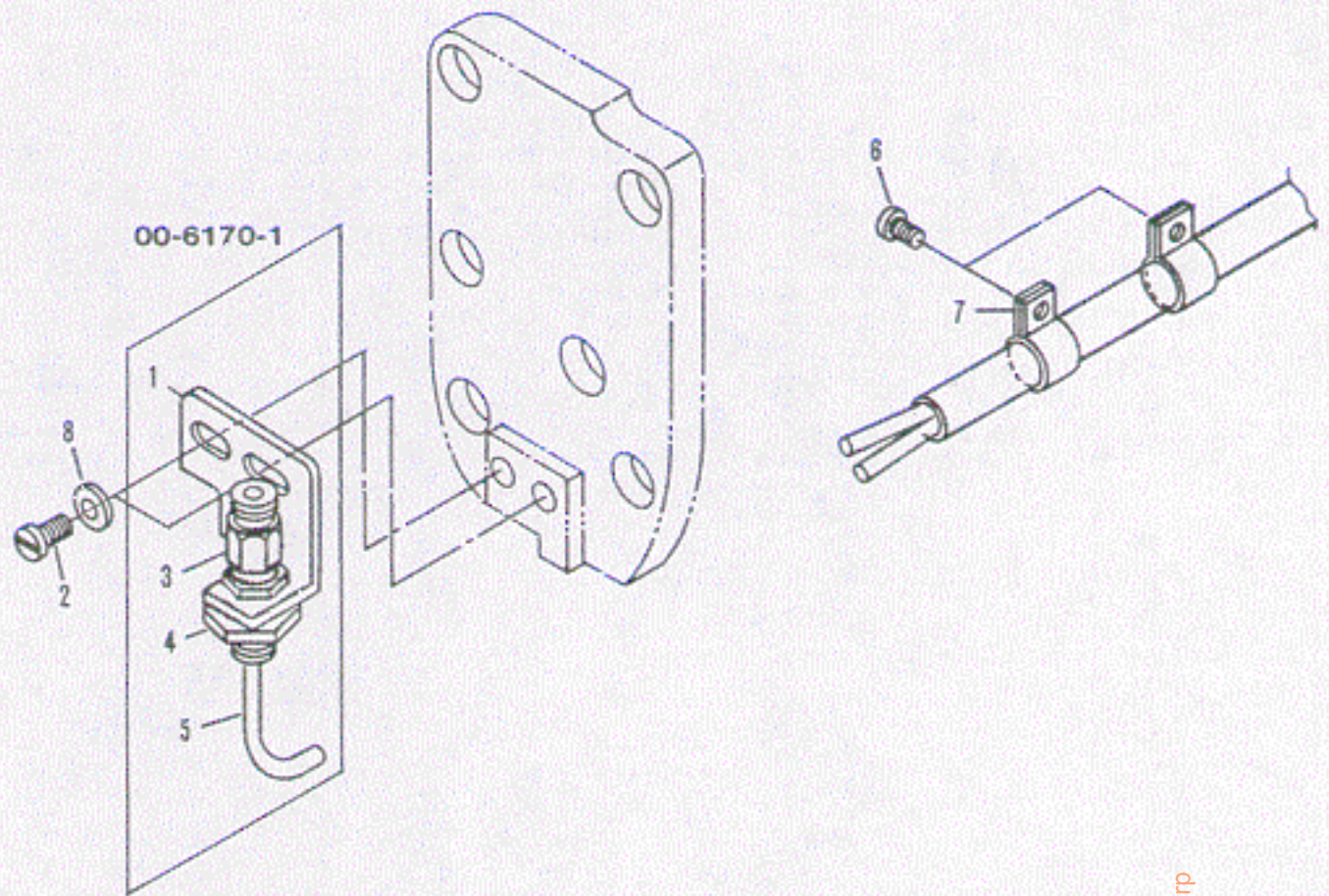

From the library of: Diamond Needle Corp

No.	Part No.	Part Name	品名	Q, ty
1	06-1710-0	Thread airflow mounting bracket	糸吹きパイプ取付台	1
2	84-5660-0	Screw	ネジ	2
3	09-9480-0	Joint	ジョイント	1
4	86-8010-0	Nut	ナット	1
5	06-1740-1	Pipe	パイプ	1
6	84-5640-0	Screw	ネジ	2
7	06-9350-0	Wiper cord guard	配線サポーター	2
8	75-4560-0	Washer	ワッシャ	2

15. Knee lifter components (膝揚げ機構)

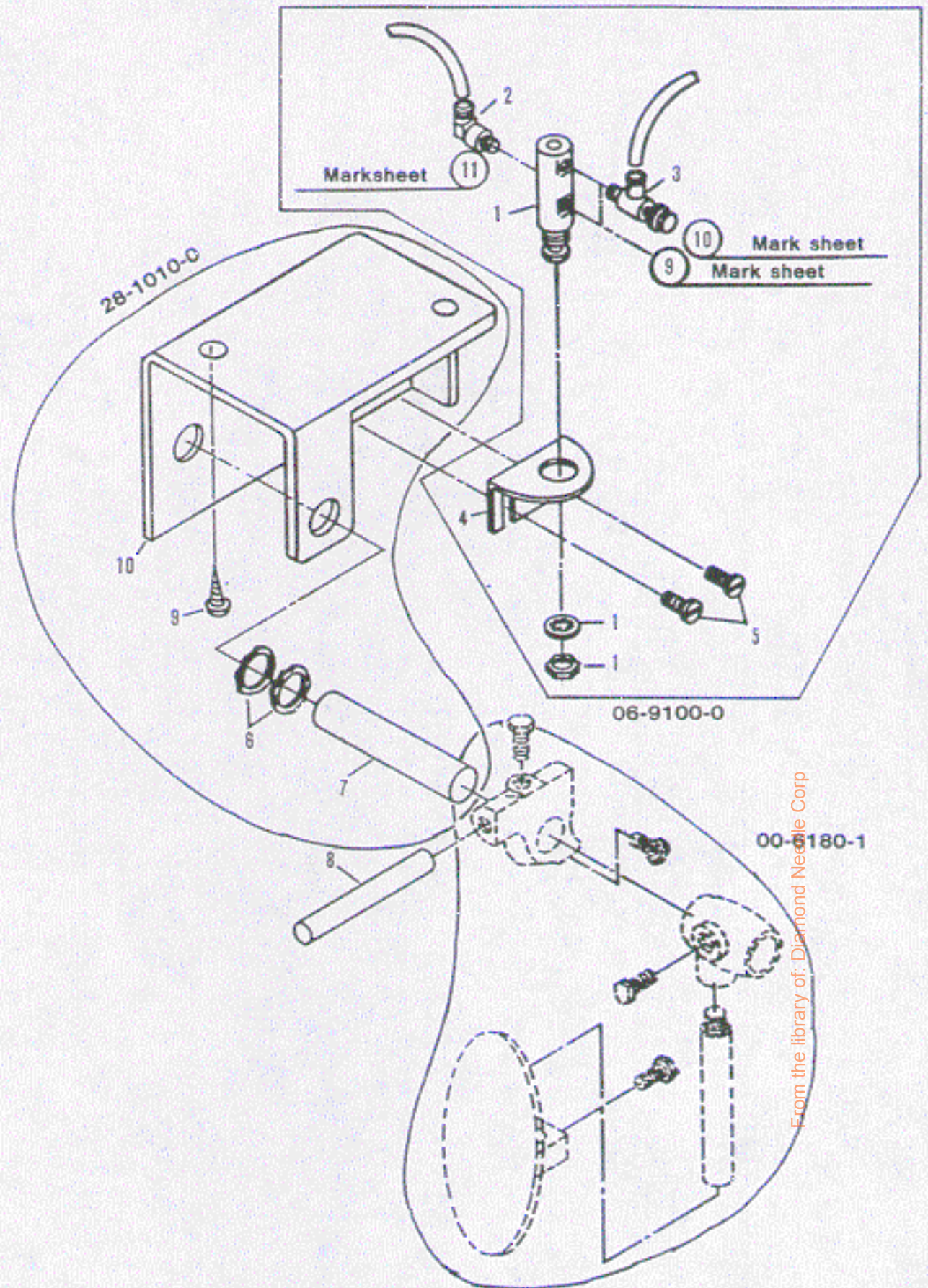

From the library of: Diamond Needle Corp

No.	Part No.	Part name	品名	Q, ty
1	06-5410-0	Valve	手動弁 4P	1
2	06-9790-0	L-type joint	ジョイント GL4-M5	1
3	06-5430-0	Speed controller	スピードコントローラー	1
4	06-5420-0	Bracket	ブラケット 8-600	1
5	84-5710-0	Screw	ネジ	2
6	02-1120-0	Washer	ワッシャ	2
7	06-1840-0	Shaft	シャフト	1
8	09-1750-0	Shaft	シャフト	1
9	87-9010-0	Screw	ネジ	2
10	06-1810-0	Bracket	ブラケット	1

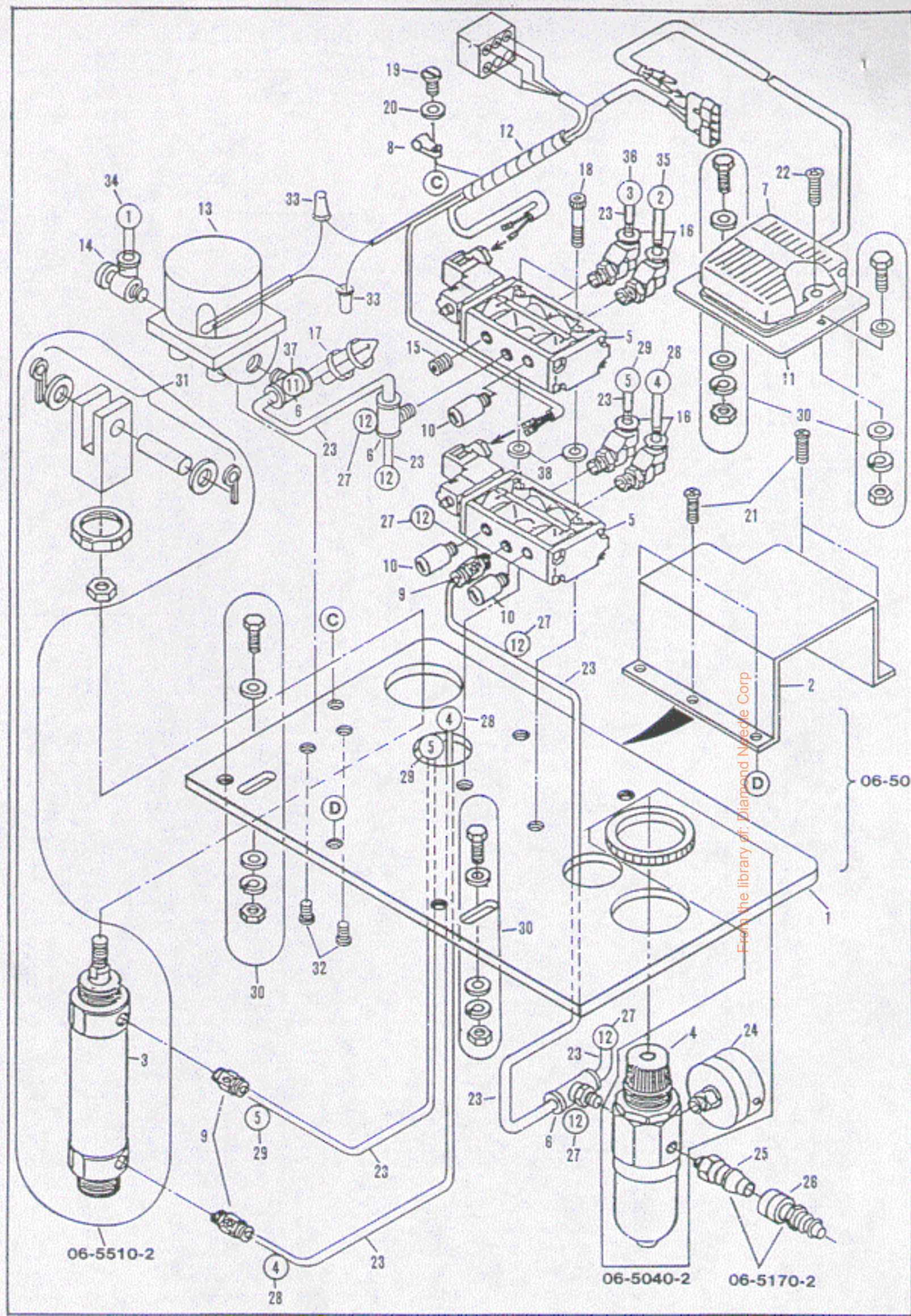







06-9040-2

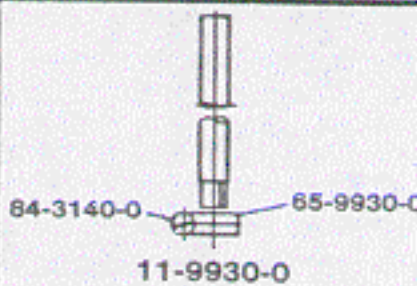
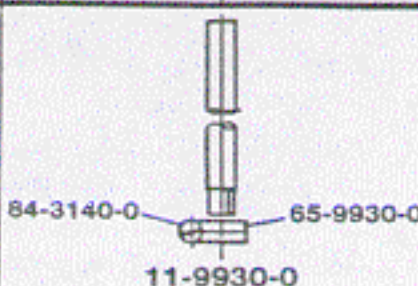
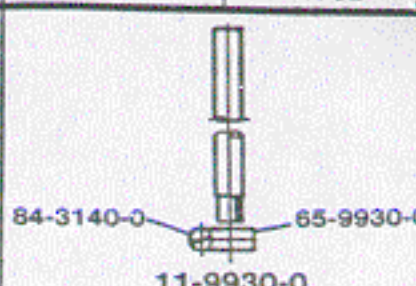
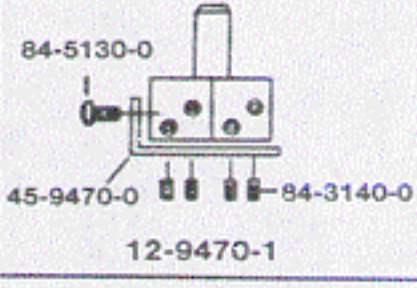
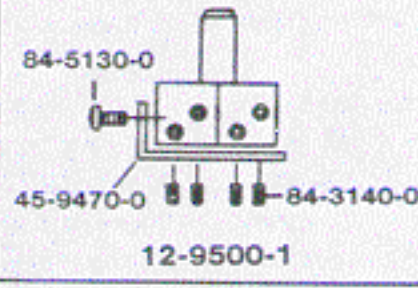
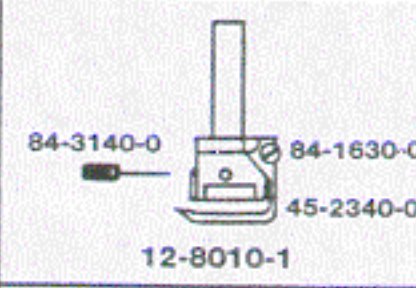
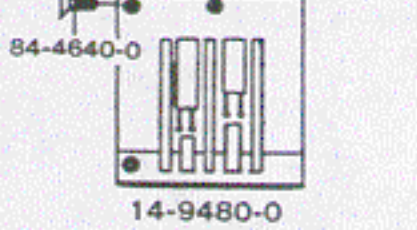
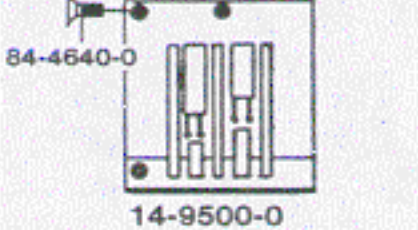
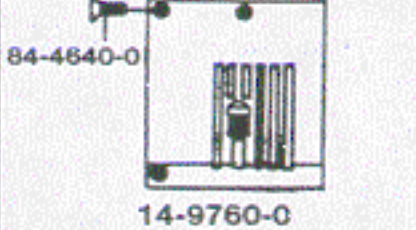
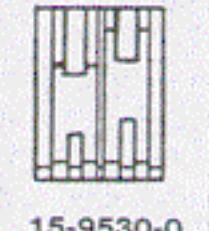
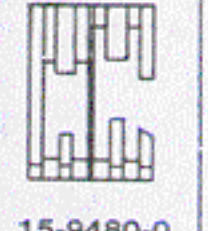
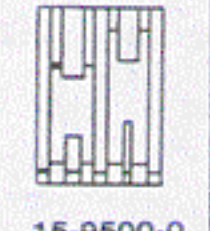
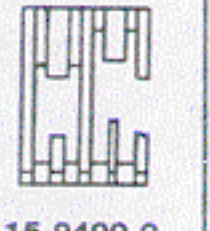
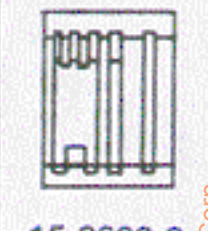
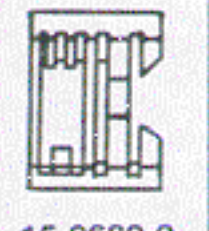
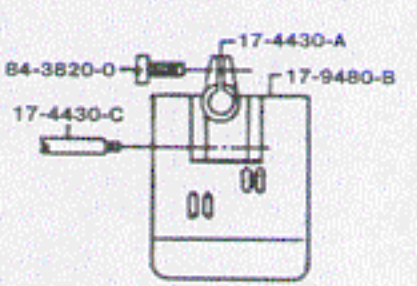
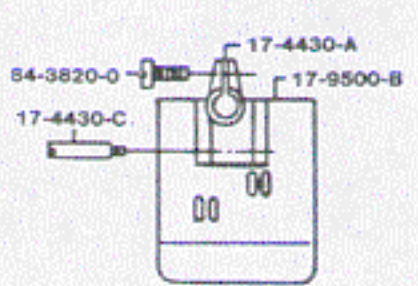
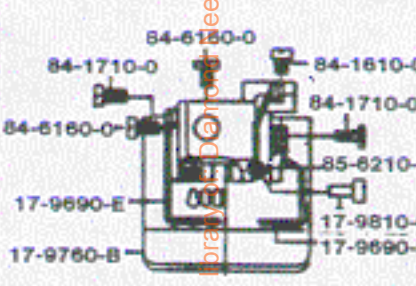
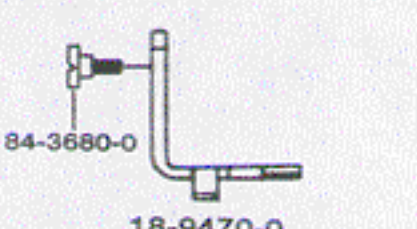
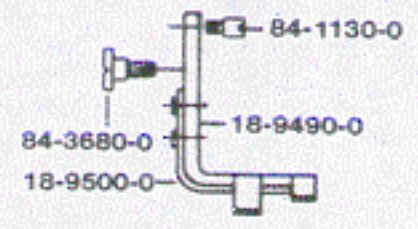
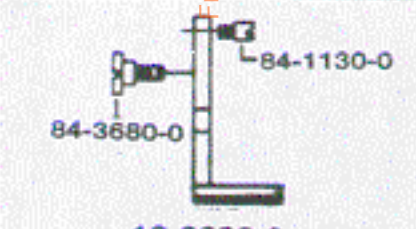
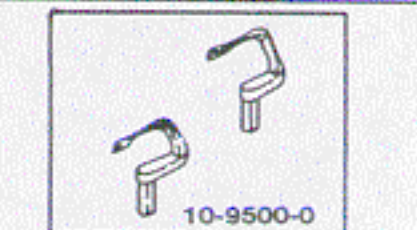
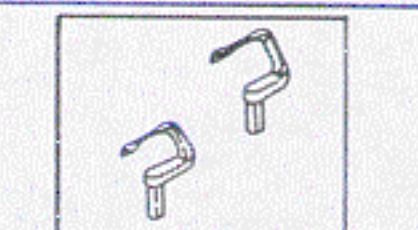



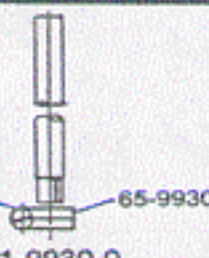
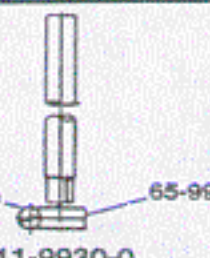
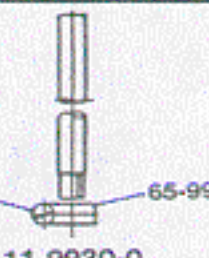
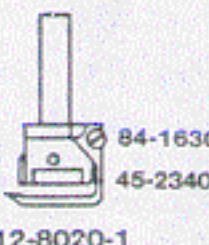
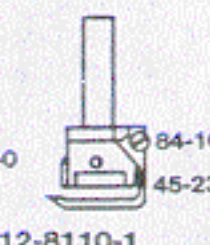
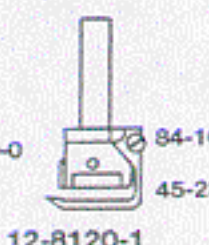
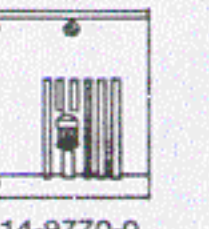
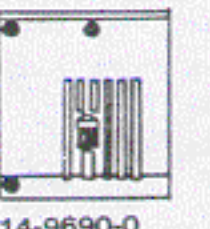
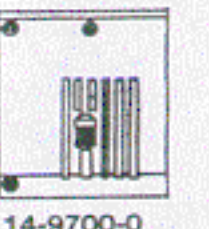
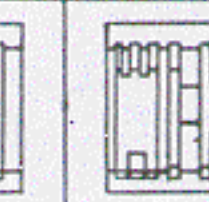
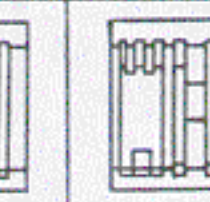
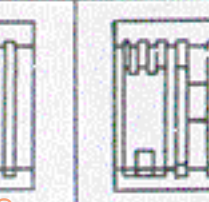
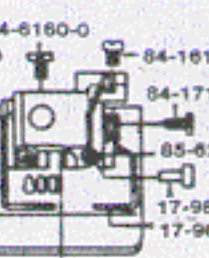
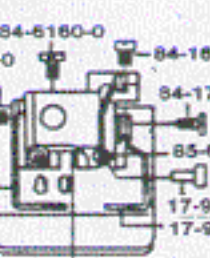
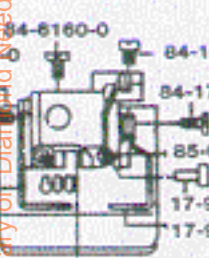
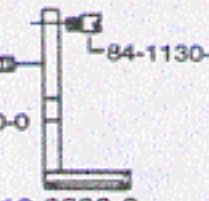
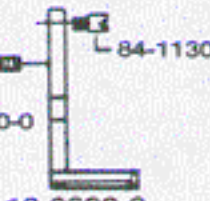
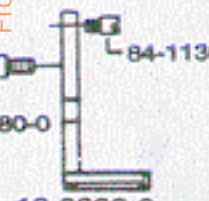





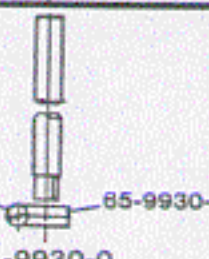
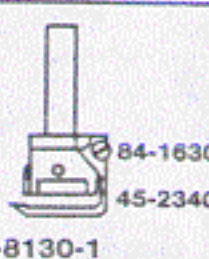

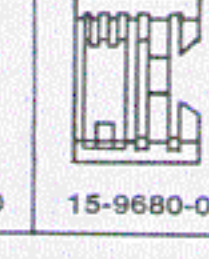
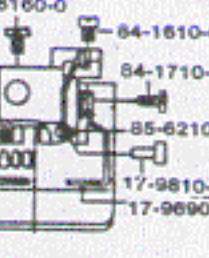
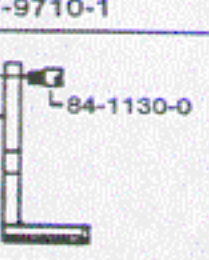





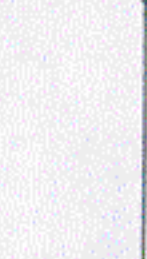

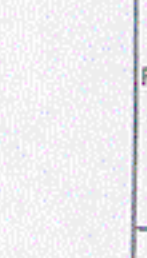

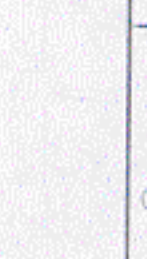



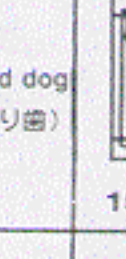
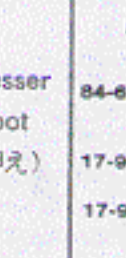

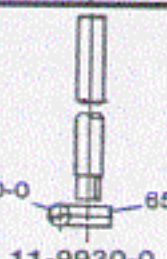
41



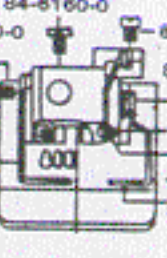
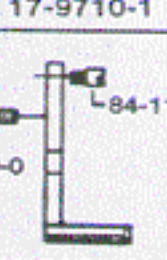
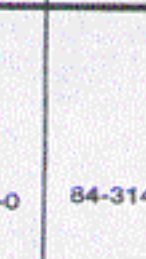
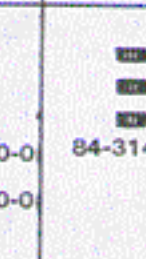
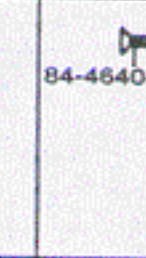
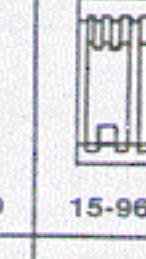
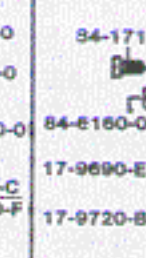
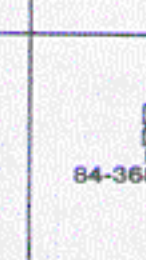



No.	Part No.	Part Name	品名	Q. ty
1	06-5010-0	Base plate	ベースプレート	1
2	06-5020-0	Cover	カバー	1
3	06-5510-0	Air cylinder (50mm)	シリンダー (Yナックル付) 50mm	1
4	06-5040-0	Regulator	レギュレーター本体	1
5	06-5060-0	Solenoid valve	電磁弁	2
6	06-9780-0	T-type joint	ジョイントGT4-6	3
7	06-5350-0	Foot switch with wiring harness	フットスイッチ (配線コード付)	1set
8	06-5120-0	Wire mount	線止めサドル	1
9	06-2960-0	Joint	ジョイントGS4-6	3
10	06-5150-0	Silencer	サイレンサー	3
11	06-5520-0	Foot pedal base	フットペダルベース (ネジ付)	1set
12	06-3040-0	Wiring harness set	配線コードセット	1set
13	06-5070-0	Regulator	電磁弁P2	1
14	06-5080-0	Speed controller	スピードコントローラー	1
15	06-5220-0	Plug	穴アキ栓	1
16	06-5190-0	L-type joint	ジョイントGL4-6	4
17	06-5230-0	Plug	栓	1set
18	87-2070-0	Screw	ネジ	2
19	87-2090-0	Screw	ネジ	1
20	06-3170-0	Washer	ワッシャー	1
21	06-3160-0	Screw	ネジ	5
22	06-3180-0	Screw	ネジ	2
23	09-9400-0	Air tube 2m	ジュンロンチューブ2m	3
24	06-5210-0	Regulator gauge	レギュレーター用メーター	1
25	06-5170-0	Coupler	カブラオス	1
26	06-5160-0	Socket pipe	カブラメス	1
27	06-5720-0	Mark sheet No12	マークシートNo12	7
28	06-5640-0	Mark sheet No4	マークシートNo4	4
29	06-5650-0	Mark sheet No5	マークシートNo5	4
30	80-7520-0	Mounting set	ボルトセット	4set
31	06-5510-1	Y-knuckle	シリンダー用Y-ナックル	1set
32	87-2080-0	Screw	ネジ	2
33	06-3150-0	Capsule terminal	カプセル端子	2
34	06-5610-0	Mark sheet No1	マークシートNo1	3
35	06-5620-0	Mark sheet No2	マークシートNo2	4
36	06-5630-0	Mark sheet No3	マークシートNo3	4
37	06-5710-0	Mark sheet No11	マークシートNo11	3
38	75-3940-0	Collar	カラー	2

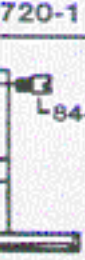

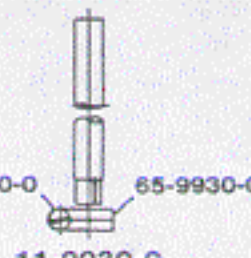
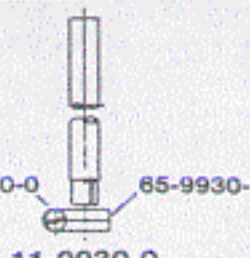
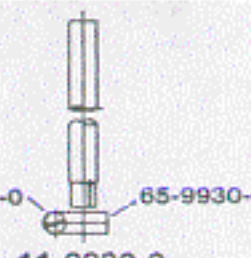
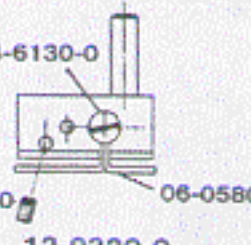
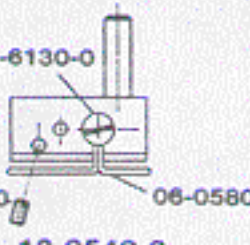
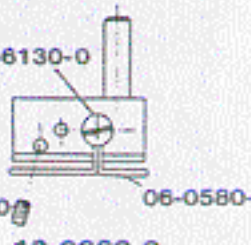

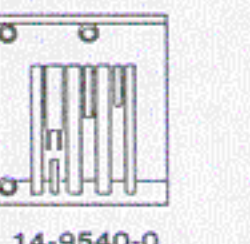
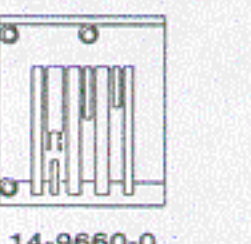
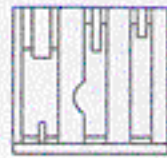
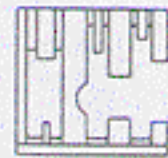
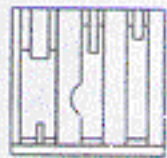
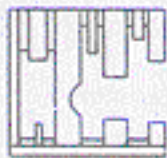
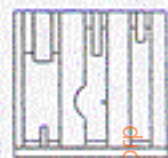
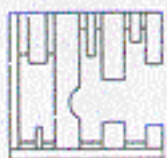
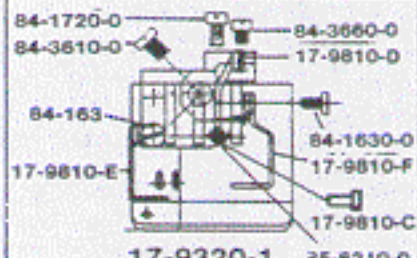
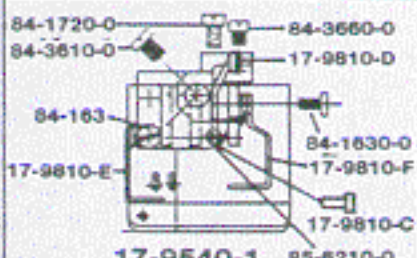
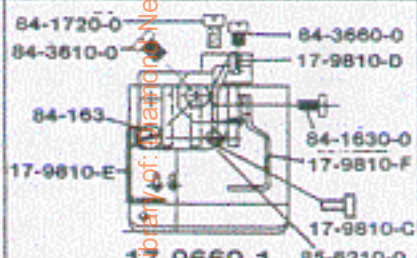
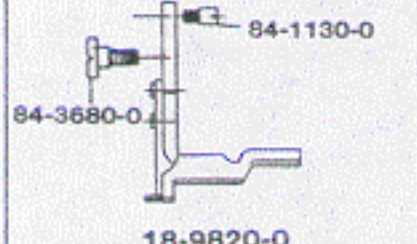
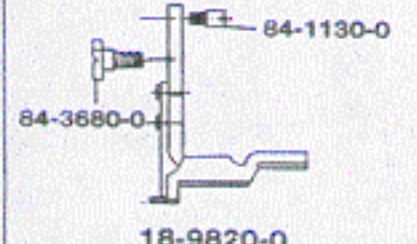
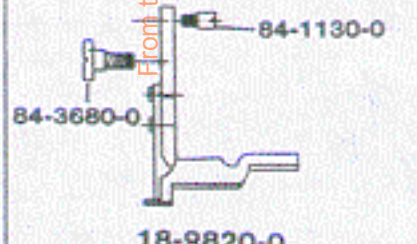

From the library of: Diamond Needle Corp

	1904U 4-7-4mm	1904U/UC 4-7-4mm	1904U 4-8.5-3.2mm	1904U/UTC 4-8.5-3.2mm	1903U-M 7/32	1903U-M/UTC 7/32
Needle bar (針棒)	 <p>84-3140-0 65-9930-0 11-9930-0</p>		 <p>84-3140-0 65-9930-0 11-9930-0</p>		 <p>84-3140-0 65-9930-0 11-9930-0</p>	
Needle holder (針株)	 <p>84-5130-0 45-9470-0 84-3140-0 12-9470-1</p>		 <p>84-5130-0 45-9470-0 84-3140-0 12-9500-1</p>		 <p>84-3140-0 84-1630-0 45-2340-0 12-8010-1</p>	
Needle plate (針板)	 <p>84-4640-0 14-9480-0</p>		 <p>84-4640-0 14-9500-0</p>		 <p>84-4640-0 14-9760-0</p>	
Feed dog (送り歯)	 <p>15-9530-0</p>	 <p>15-9480-0</p>	 <p>15-9500-0</p>	 <p>15-9490-0</p>	 <p>15-9690-0</p>	 <p>15-9680-0</p>
Presser foot (押え)	 <p>84-3820-0 17-4430-A 17-4430-C 17-9480-B 17-9480-1</p>		 <p>84-3820-0 17-4430-A 17-4430-C 17-9500-B 17-9500-1</p>		 <p>84-6160-0 84-1610-0 84-1710-0 84-1710-0 84-6160-0 85-6210-0 17-9690-E 17-9810-C 17-9760-B 17-9690-F 17-9760-1</p>	
Needle guard (針受け)	 <p>84-3680-0 18-9470-0</p>		 <p>84-1130-0 84-3680-0 18-9490-0 18-9500-0</p>		 <p>84-1130-0 84-3680-0 18-9690-0</p>	
Looper (ルーパー)	 <p>10-9500-0 19-9500-0, 19-9570-0</p>		 <p>19-9500-0, 19-9550-0</p>		 <p>19-7130-0</p>	

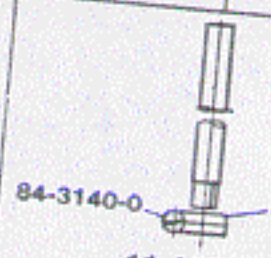
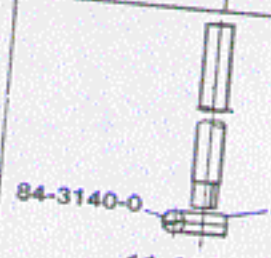
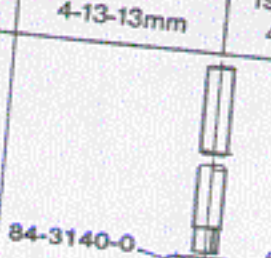
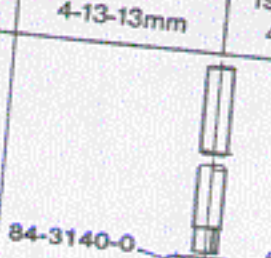
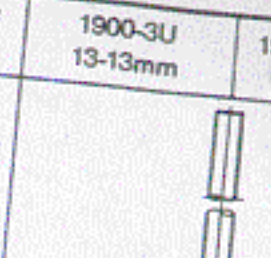
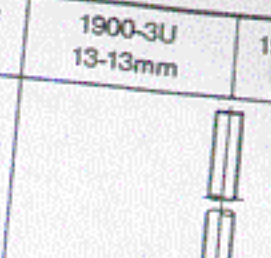
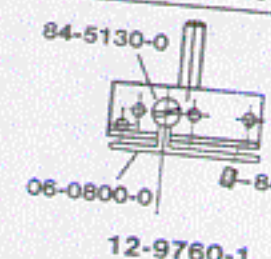
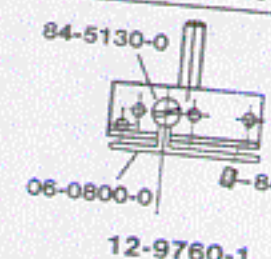
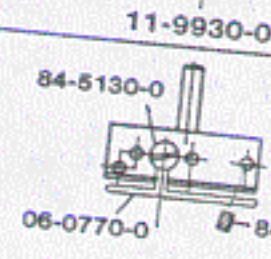
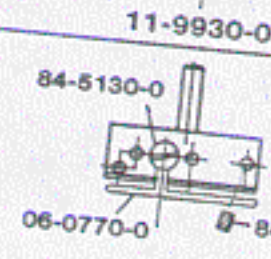
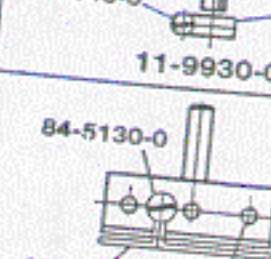
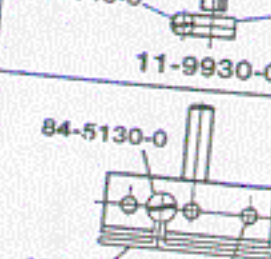
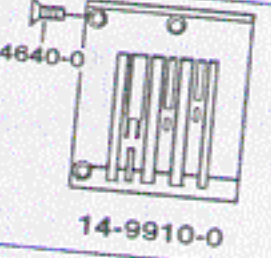
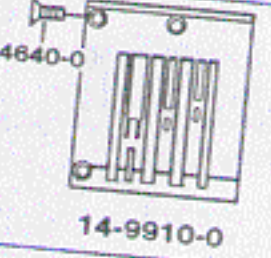
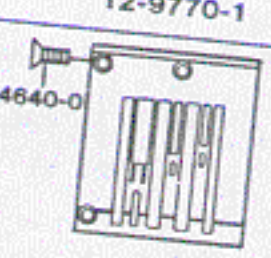
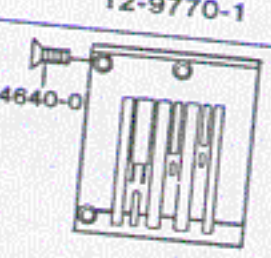
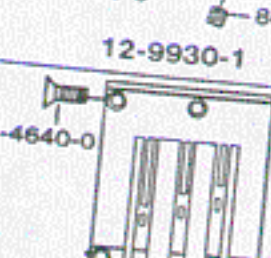
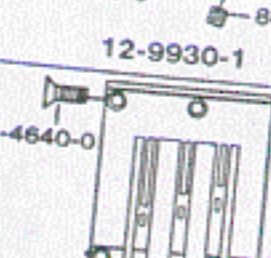
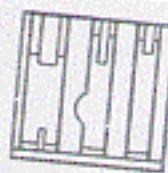
	1903U-M 1/4	1903U-M/UTC 1/4	1902U-M 1/8	1902U-M/UTC 1/8	1902U-M 5/32	1902U-M/UTC 5/32
Needle bar (針棒)	 <p>84-3140-0 65-9930-0 11-9930-0</p>		 <p>84-3140-0 65-9930-0 11-9930-0</p>		 <p>84-3140-0 65-9930-0 11-9930-0</p>	
Needle holder (針株)	 <p>84-3140-0 84-1630-0 45-2340-0 12-8020-1</p>		 <p>84-3140-0 84-1630-0 45-2340-0 12-8110-1</p>		 <p>84-3140-0 84-1630-0 45-2340-0 12-8120-1</p>	
Needle plate (針板)	 <p>84-4640-0 14-9770-0</p>		 <p>84-4640-0 14-9690-0</p>		 <p>84-4640-0 14-9700-0</p>	
Feed dog (送り歯)	 <p>15-9690-0 15-9680-0</p>		 <p>15-9690-0 15-9680-0</p>		 <p>15-9690-0 15-9680-0</p>	
Presser foot (押え)	 <p>84-6160-0 84-1710-0 84-1610-0 84-6160-0 85-6210-0 17-9690-E 17-9810-C 17-9770-B 17-9690-F 17-9770-1</p>		 <p>84-6160-0 84-1710-0 84-1610-0 84-6160-0 85-6210-0 17-9690-E 17-9810-C 17-9690-B 17-9690-F 17-9690-1</p>		 <p>84-6160-0 84-1710-0 84-1610-0 84-6160-0 85-6210-0 17-9690-E 17-9810-C 17-9700-B 17-9690-F 17-9700-1</p>	
Needle guard (針受け)	 <p>84-3680-0 84-1130-0 18-9690-0</p>		 <p>84-3680-0 84-1130-0 18-9690-0</p>		 <p>84-3680-0 84-1130-0 18-9690-0</p>	
Looper (ルーパー)	 <p>19-7130-0</p>		 <p>19-7130-0</p>		 <p>19-7130-0</p>	

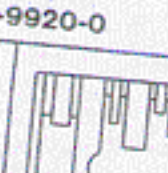
	1902U-M 3/16	1902U-M/UTC 3/16	1902U-M 7/32	1902U-M/UTC 7/32	1902U-M 1/4	1902U-M/UTC 1/4
Needle bar (針棒)	 84-3140-0 85-9930-0 11-9930-0	 84-3140-0 85-9930-0 11-9930-0	 84-3140-0 85-9930-0 11-9930-0	 84-3140-0 85-9930-0 11-9930-0	 84-3140-0 85-9930-0 11-9930-0	 84-3140-0 85-9930-0 11-9930-0
Needle holder (針株)	 84-3140-0 84-1630-0 45-2340-0 12-8130-1	 84-3140-0 84-1630-0 45-2340-0 12-8140-1	 84-3140-0 84-1630-0 45-2340-0 12-8140-1	 84-3140-0 84-1630-0 45-2340-0 12-8140-1	 84-3140-0 84-1630-0 45-2340-0 12-8150-1	 84-3140-0 84-1630-0 45-2340-0 12-8150-1
Needle plate (針板)	 84-4640-0 14-9710-0	 84-4640-0 14-9720-0	 84-4640-0 14-9720-0	 84-4640-0 14-9720-0	 84-4640-0 14-9730-0	 84-4640-0 14-9730-0
Feed dog (送り歯)	 15-9690-0	 15-9680-0	 15-9690-0	 15-9680-0	 15-9690-0	 15-9680-0
Presser foot (押え)	 84-8160-0 84-1710-0 84-1610-0 84-1710-0 84-8160-0 85-6210-0 17-9690-E 17-9810-C 17-9710-B 17-9690-F 17-9710-1	 84-8160-0 84-1710-0 84-1610-0 84-1710-0 84-8160-0 85-6210-0 17-9690-E 17-9810-C 17-9720-B 17-9690-F 17-9720-1	 84-8160-0 84-1710-0 84-1610-0 84-1710-0 84-8160-0 85-6210-0 17-9690-E 17-9810-C 17-9730-B 17-9690-F 17-9730-1	 84-8160-0 84-1710-0 84-1610-0 84-1710-0 84-8160-0 85-6210-0 17-9690-E 17-9810-C 17-9730-B 17-9690-F 17-9730-1	 84-8160-0 84-1710-0 84-1610-0 84-1710-0 84-8160-0 85-6210-0 17-9690-E 17-9810-C 17-9730-B 17-9690-F 17-9730-1	 84-8160-0 84-1710-0 84-1610-0 84-1710-0 84-8160-0 85-6210-0 17-9690-E 17-9810-C 17-9730-B 17-9690-F 17-9730-1
Needle guard (針受け)	 84-3680-0 84-1130-0 18-9690-0	 84-3680-0 84-1130-0 18-9690-0	 84-3680-0 84-1130-0 18-9690-0	 84-3680-0 84-1130-0 18-9690-0	 84-3680-0 84-1130-0 18-9690-0	 84-3680-0 84-1130-0 18-9690-0
Looper (ルーパー)	 19-7130-0	 19-7130-0	 19-7130-0	 19-7130-0	 19-7130-0	 19-7130-0

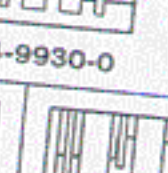
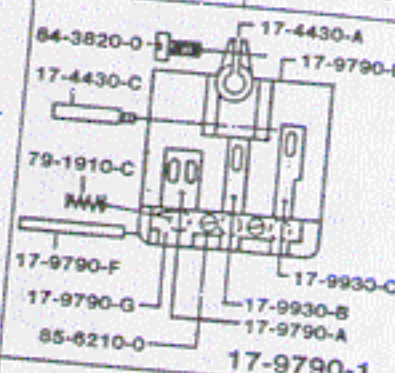
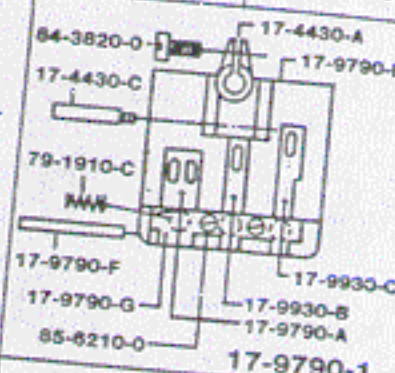
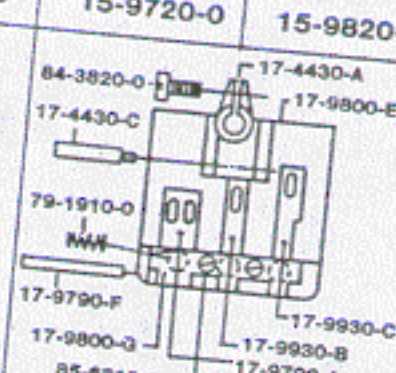
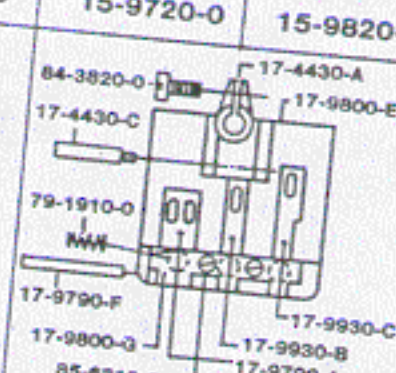
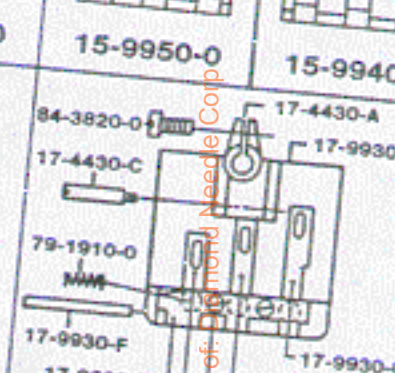
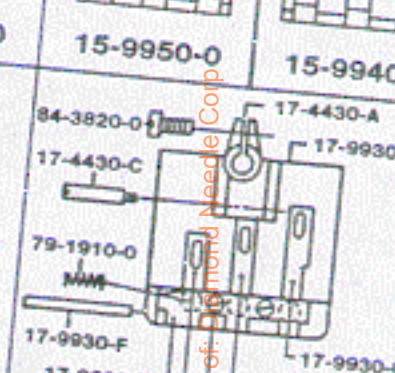
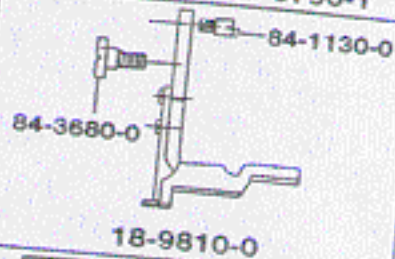
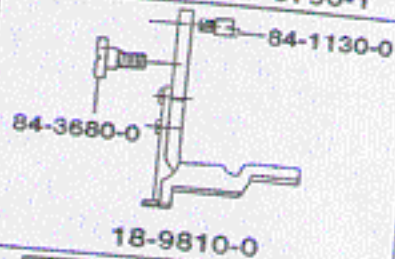
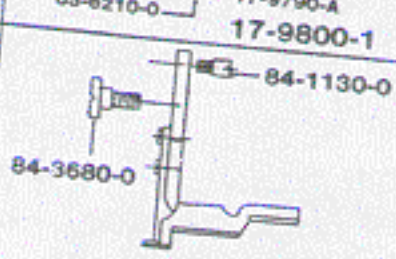
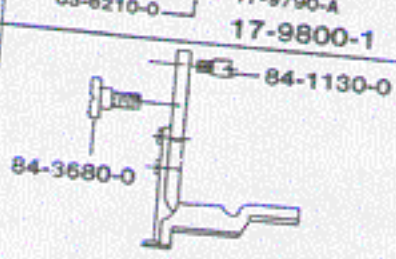
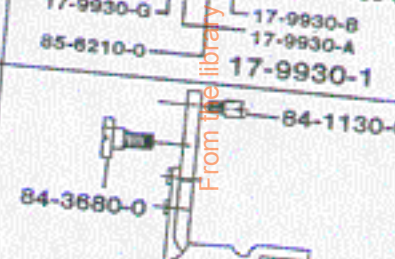
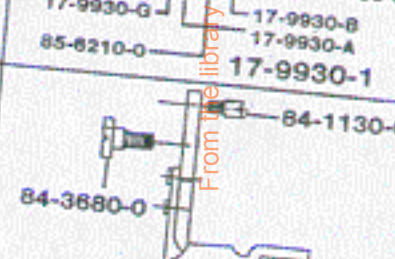
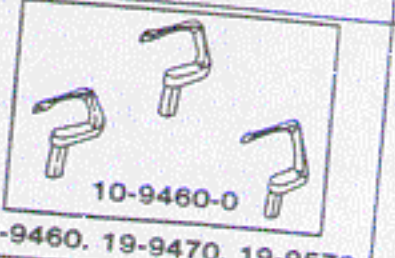
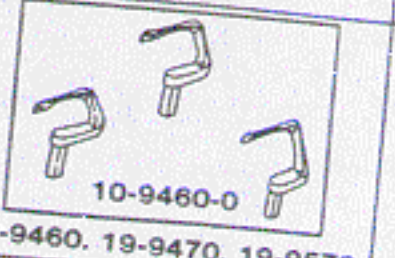
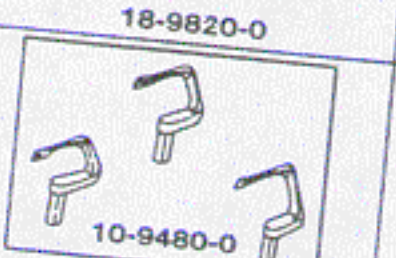
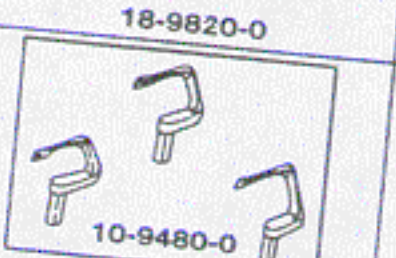
	1902U-W 3/16"	1902U-W 3/16"	1902U-W 7/32"	1902U-W 7/32"	1902U-W 1/4"	1902U-W 7/32"
Needle bar (針棒)	 <p>84-3140-0 65-9930-0 11-9930-0</p>		 <p>84-3140-0 65-9930-0 11-9930-0</p>		 <p>84-3140-0 65-9930-0 11-9930-0</p>	
Needle holder (針採)	 <p>84-6130-0 84-3140-0 06-0580-0 12-9320-0</p>		 <p>84-6130-0 84-3140-0 06-0580-0 12-9540-0</p>		 <p>84-6130-0 84-3140-0 06-0580-0 12-9660-0</p>	
Needle plate (針板)	 <p>14-9320-0</p>		 <p>14-9540-0</p>		 <p>14-9660-0</p>	
Feed dog (送り歯)	 <p>15-9720-0</p>	 <p>15-9820-0</p>	 <p>15-9720-0</p>	 <p>15-9820-0</p>	 <p>15-9720-0</p>	 <p>15-9820-0</p>
Presser foot (押え)	 <p>84-1720-0 84-3660-0 84-3610-0 17-9810-D 84-163 84-1630-0 17-9810-F 17-9810-E 17-9810-C 17-9320-1 35-8210-0</p>		 <p>84-1720-0 84-3660-0 84-3610-0 17-9810-D 84-163 84-1630-0 17-9810-F 17-9810-E 17-9810-C 17-9540-1 85-8210-0</p>		 <p>84-1720-0 84-3660-0 84-3610-0 17-9810-D 84-163 84-1630-0 17-9810-F 17-9810-E 17-9810-C 17-9660-1 85-8210-0</p>	
Needle guard (針受け)	 <p>84-1130-0 84-3680-0 18-9820-0</p>		 <p>84-1130-0 84-3680-0 18-9820-0</p>		 <p>84-1130-0 84-3680-0 18-9820-0</p>	
Looper (ルーバー)	 <p>19-7120-0</p>		 <p>19-7120-0</p>		 <p>19-7120-0</p>	

	4-10-10mm	4-10-10mm	1902-2U 4-13-13mm	1902-2U/UTC 4-13-13mm	1900-3U 13-13mm	1900-3U/UTC 13-13mm
Needle bar (針棒)	 84-3140-0 65-9930-0 11-9930-0	 84-3140-0 65-9930-0 11-9930-0	 84-3140-0 65-9930-0 11-9930-0	 84-3140-0 65-9930-0 11-9930-0	 84-3140-0 65-9930-0 11-9930-0	 84-3140-0 65-9930-0 11-9930-0
Needle holder (針株)	 84-5130-0 06-0800-0 84-3140-0 12-9760-1	 84-5130-0 06-0800-0 84-3140-0 12-9760-1	 84-5130-0 06-0770-0 84-3140-0 12-9770-1	 84-5130-0 06-0770-0 84-3140-0 12-9770-1	 84-5130-0 06-0770-0 84-3140-0 12-9930-1	 84-5130-0 06-0770-0 84-3140-0 12-9930-1
Needle plate (針板)	 84-4640-0 14-9910-0	 84-4640-0 14-9910-0	 84-4640-0 14-9920-0	 84-4640-0 14-9920-0	 84-4640-0 14-9930-0	 84-4640-0 14-9930-0
Feed dog (送り歯)	 15-9700-0	 15-9800-0	 15-9720-0	 15-9820-0	 15-9950-0	 15-9940-0
Presser foot (押え)	 84-3820-0 17-4430-A 17-4430-C 79-1910-C 17-9790-F 17-9790-G 85-6210-0 17-4430-A 17-9790-E 17-9930-C 17-9930-B 17-9790-A 17-9790-1	 84-3820-0 17-4430-A 17-4430-C 79-1910-C 17-9790-F 17-9790-G 85-6210-0 17-4430-A 17-9790-E 17-9930-C 17-9930-B 17-9790-A 17-9790-1	 84-3820-0 17-4430-A 17-4430-C 79-1910-C 17-9790-F 17-9790-G 85-6210-0 17-4430-A 17-9790-E 17-9930-C 17-9930-B 17-9790-A 17-9800-1	 84-3820-0 17-4430-A 17-4430-C 79-1910-C 17-9790-F 17-9790-G 85-6210-0 17-4430-A 17-9790-E 17-9930-C 17-9930-B 17-9790-A 17-9800-1	 84-3820-0 17-4430-A 17-4430-C 79-1910-C 17-9790-F 17-9790-G 85-6210-0 17-4430-A 17-9790-E 17-9930-C 17-9930-B 17-9930-A 17-9930-1	 84-3820-0 17-4430-A 17-4430-C 79-1910-C 17-9790-F 17-9790-G 85-6210-0 17-4430-A 17-9790-E 17-9930-C 17-9930-B 17-9930-A 17-9930-1
Needle guard (針受け)	 84-1130-0 84-3680-0 18-9810-0	 84-1130-0 84-3680-0 18-9810-0	 84-1130-0 84-3680-0 18-9820-0	 84-1130-0 84-3680-0 18-9820-0	 84-1130-0 84-3680-0 18-9930-0	 84-1130-0 84-3680-0 18-9930-0
Looper (ループ)	 10-9460-0 19-9460. 19-9470. 19-9570	 10-9460-0 19-9460. 19-9470. 19-9570	 10-9480-0 19-9480. 19-9590. 19-9660	 10-9480-0 19-9480. 19-9590. 19-9660	 10-9930-0 19-9930. 19-9940. 19-9950	 10-9930-0 19-9930. 19-9940. 19-9950

	19004U 1"	19004U/UTC 1"	19004U 3/4"	19004U/UTC 3/4"	19004U 1 1/4"	19004U/UTC 1 1/4"
Needle bar (針棒)	<p>84-3140-0 65-9930-0 11-9930-0</p>		<p>84-3140-0 65-9930-0 11-9930-0</p>		<p>84-3140-0 65-9930-0 11-9930-0</p>	
Needle holder (針株)	<p>84-6130-0 06-0790-0 84-3140-0 12-9780-1</p>		<p>84-6130-0 06-0780-0 84-3140-0 12-9960-1</p>		<p>84-6130-0 06-0790-0 84-3140-0 12-9900-1</p>	
Needle plate (針板)	<p>84-4640-0 14-9880-0</p>		<p>84-4640-0 14-9960-0</p>		<p>84-4640-0 14-9900-0</p>	
Feed dog (送り歯)	<p>15-9970-0</p>	<p>15-9880-0</p>	<p>15-9980-0</p>	<p>15-9960-0</p>	<p>15-9990-0</p>	<p>15-9900-0</p>
Presser foot (押え)	<p>84-3920-0 17-4430-A 17-4430-C 17-9870-E 79-1910-0 17-9870-F 17-9870-G 85-6210-0 17-9870-1 17-9870-A</p>		<p>84-3820-0 17-4430-A 17-4430-C 17-9960-E 79-1910-0 17-9870-F 17-9960-G 85-6210-0 17-9960-1 17-9870-A</p>		<p>84-3820-0 17-4430-A 17-4430-C 17-990-E 79-1910-0 17-9870-F 17-9900-G 85-6210-0 17-9900-1 17-9870-A</p>	
Needle guard (針受け)	<p>84-3680-0 84-1130-0 18-9400-0</p>		<p>84-3680-0 84-1130-0 18-5460-0</p>		<p>84-3680-0 84-1130-0 18-5420-0</p>	
Looper (ループ)	<p>10-9490-0 19-949.19-958.19-968.19-975</p>		<p>10-9970-0 19-958.19-996.19-997.19-998</p>		<p>10-9900-0 19-958.19-990.19-991.19-992</p>	

鋼 種	Nilebar clamp plate		feed		foot		guard		looper		upper holder		support plate		cloth plate	
	寸	寸	寸	寸	寸	寸	寸	寸	寸	寸	寸	寸	寸	寸	寸	寸
1902U中鉄	1/8	11-9930	12-8110-1	14-9630	15-9690	17-9690-1	18-9690	19-7130-0	10-9400-1	14-0970-2	21-9260					
	5/32	11-9930	12-8120-1	14-9700	15-9690	17-9700-1	18-9690	19-7130-0	10-9400-1	14-0970-2	21-9260					
	3/16	11-9930	12-8130-1	14-9710	15-9690	17-9710-1	18-9690	19-7130-0	10-9400-1	14-0970-2	21-9260					
	7/32	11-9930	12-8140-1	14-9720	15-9690	17-9720-1	18-9690	19-7130-0	10-9400-1	14-0970-2	21-9260					
	1/4	11-9930	12-8150-1	14-9730	15-9690	17-9730-1	18-9690	19-7130-0	10-9400-1	14-0970-2	21-9260					
1903U中鉄	7/32	11-9930	12-8010-1	14-9760	15-9690	17-9760-1	18-9690	19-7130-0	10-9400-1	14-0970-2	21-9260					
	1/4	11-9930	12-8020-1	14-9770	15-9690	17-9770-1	18-9690	19-7130-0	10-9400-1	14-0970-2	21-9260					
1902U/UTC中鉄	1/8	11-9930	12-8110-1	14-9690	15-9690	17-9690-1	18-9690	19-7130-0	10-9400-1	14-0970-2	21-9260					
	5/32	11-9930	12-8120-1	14-9700	15-9690	17-9700-1	18-9690	19-7130-0	10-9400-1	14-0970-2	21-9260					
	3/16	11-9930	12-8130-1	14-9710	15-9690	17-9710-1	18-9690	19-7130-0	10-9400-1	14-0970-2	21-9260					
	7/32	11-9930	12-8140-1	14-9720	15-9690	17-9720-1	18-9690	19-7130-0	10-9400-1	14-0970-2	21-9260					
	1/4	11-9930	12-8150-1	14-9730	15-9690	17-9730-1	18-9690	19-7130-0	10-9400-1	14-0970-2	21-9260					
1903U/UTC中鉄	7/32	11-9930	12-8010-1	14-9760	15-9690	17-9760-1	18-9690	19-7130-0	10-9400-1	14-0970-2	21-9260					
	1/4	11-9930	12-8020-1	14-9770	15-9690	17-9770-1	18-9690	19-7130-0	10-9400-1	14-0970-2	21-9260					
1902U中鉄	3/16	11-9930	12-9320-1	14-9320	15-9720	17-9320-1	18-9820	19-7120-0	10-9390-1	14-0970-2	21-9260					
	7/32	11-9930	12-9540-1	14-9540	15-9720	17-9540-1	18-9820	19-7120-0	10-9390-1	14-0970-2	21-9260					
	1/4	11-9930	12-9660-1	14-9660	15-9720	17-9660-1	18-9820	19-7120-0	10-9390-1	14-0970-2	21-9260					
1902U/UTC中鉄	3/16	11-9930	12-9660-1	14-9660	15-9720	17-9660-1	18-9820	19-7120-0	10-9390-1	14-0970-2	21-9260					
	7/32	11-9930	12-9820-1	14-9820	15-9820	17-9820-1	18-9820	19-7120-0	10-9390-1	14-0970-2	21-9260					
	1/4	11-9930	12-9820-1	14-9820	15-9820	17-9820-1	18-9820	19-7120-0	10-9390-1	14-0970-2	21-9260					
1902U中鉄	1/4	11-9930	12-9660-1	14-9660	15-9820	17-9660-1	18-9820	19-7120-0	10-9390-1	14-0970-2	21-9260					
1902U/UTC中鉄	3/16	11-9930	12-9660-1	14-9660	15-9820	17-9660-1	18-9820	19-7120-0	10-9390-1	14-0970-2	21-9260					
	7/32	11-9930	12-9820-1	14-9820	15-9820	17-9820-1	18-9820	19-7120-0	10-9390-1	14-0970-2	21-9260					
	1/4	11-9930	12-9820-1	14-9820	15-9820	17-9820-1	18-9820	19-7120-0	10-9390-1	14-0970-2	21-9260					
1904U	4-7-4	11-9930	12-9470-1	14-9480	15-9530	17-9480-1	18-9470	19-9500, 9570	10-9050-1	14-0970-2	21-9260					
1904U/UTC	4-7-4	11-9930	12-9470-1	14-9480	15-9500	17-9480-1	18-9470	19-9500, 9550	10-9050-1	14-0970-2	21-9260					
1900-3U	13-13	11-9930	12-9930-1	14-9930	15-9990	17-9930-1	18-9930	10-9930(19-9930, 9940, 9950)	10-9030-2	14-0970-2	21-9260					
1900-3U/UTC	13-13	11-9930	12-9930-1	14-9930	15-9990	17-9930-1	18-9930	10-9930(19-9930, 9940, 9950)	10-9030-2	14-0970-2	21-9260					
1900-4U	3/4	11-9930	12-9960-1	14-9960	15-9960	17-9960-1	18-9960	10-9960(19-9960, 9970, 9980)	10-9040-1	14-0970-2	21-9260					
1900-4U/UTC	3/4	11-9930	12-9960-1	14-9960	15-9960	17-9960-1	18-9960	10-9960(19-9960, 9970, 9980)	10-9040-1	14-0970-2	21-9260					
	1"	11-9930	12-9960-1	14-9960	15-9990	17-9960-1	18-9960	10-9990(19-9990, 9990, 9990)	10-9040-1	14-0970-2	21-9260					
1902-2U	4-10-10	11-9930	12-9760-1	14-9910	15-9700	17-9790-1	18-9810	10-9460(19-946, 947, 957)	10-9030-1	14-0970-2	21-9260					
	4-13-13	11-9930	12-9770-1	14-9920	15-9720	17-9800-1	18-9820	10-8480(19-948, 959, 966)	10-9030-1	14-0970-2	21-9260					
	1/4-1/4-1/4	11-9930	12-9800-1	14-9900	15-9560	17-9600-1	18-9600	10-9600(19-970, 950, 969)	10-9030-3	14-0970-2	21-9260					
1902-2U/UTC	4-10-10	11-9930	12-9760-1	14-9910	15-9700	17-9790-1	18-9810	10-9460(19-946, 947, 957)	10-9030-1	14-0970-2	21-9260					
1902-2U/UTC	4-13-13	11-9930	12-9760-1	14-9910	15-9700	17-9790-1	18-9810	10-8480(19-946, 947, 957)	10-9030-1	14-0970-2	21-9260					
1902-2U/UTC	4-13-13	11-9930	12-9700-1	14-9920	15-9820	17-9800-1	18-9820	10-9480(19-948, 949, 959)	10-9030-1	14-0970-2	21-9260					
1902-2U/UTC	1/4-1/4-1/4	11-9930	12-9600-1	14-9600	15-9600	17-9600-1	18-9600	10-9600(19-970, 950, 969)	10-9030-3	14-0970-2	21-9260					

Photo library for Diameters Needs Form

18. Thread stand, Accessories (糸立て, アクセサリー)

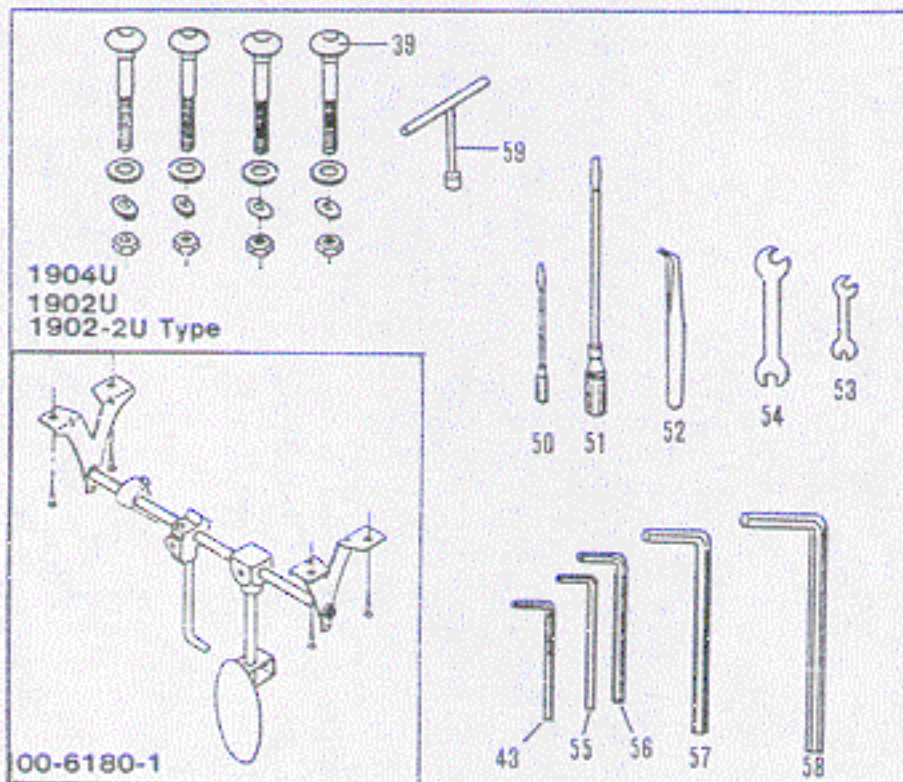
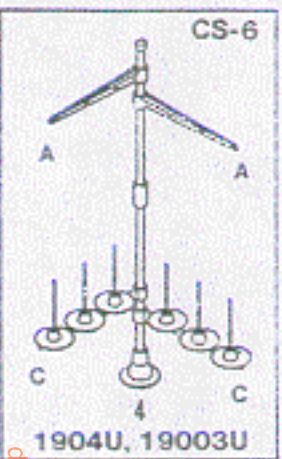
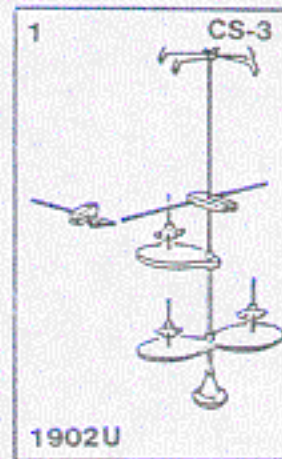
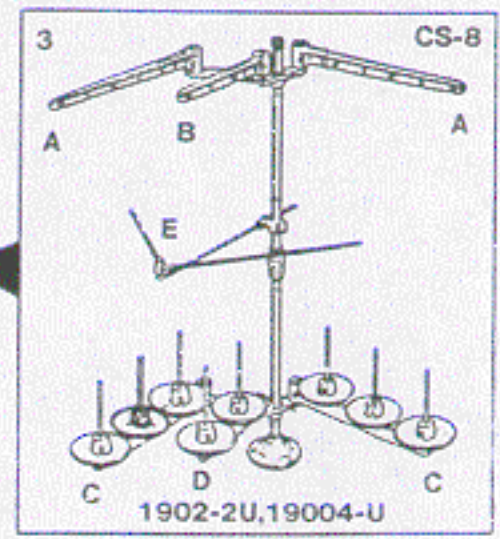
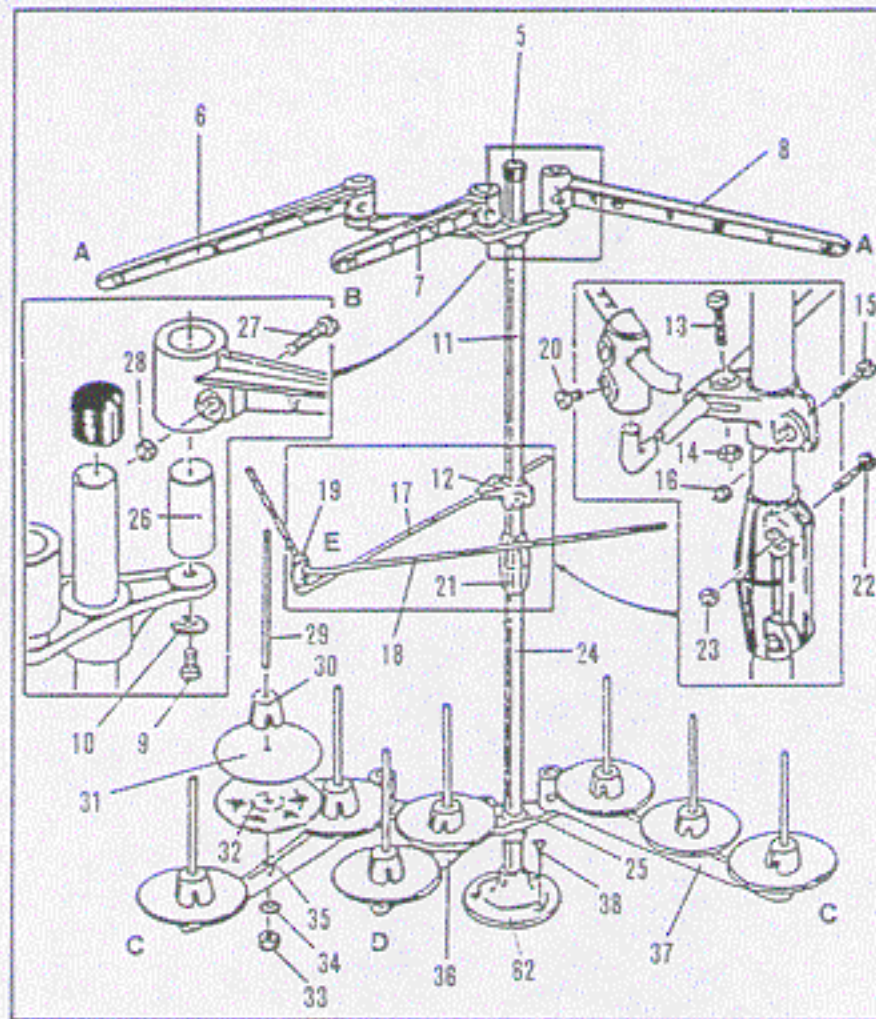

20-0020-0

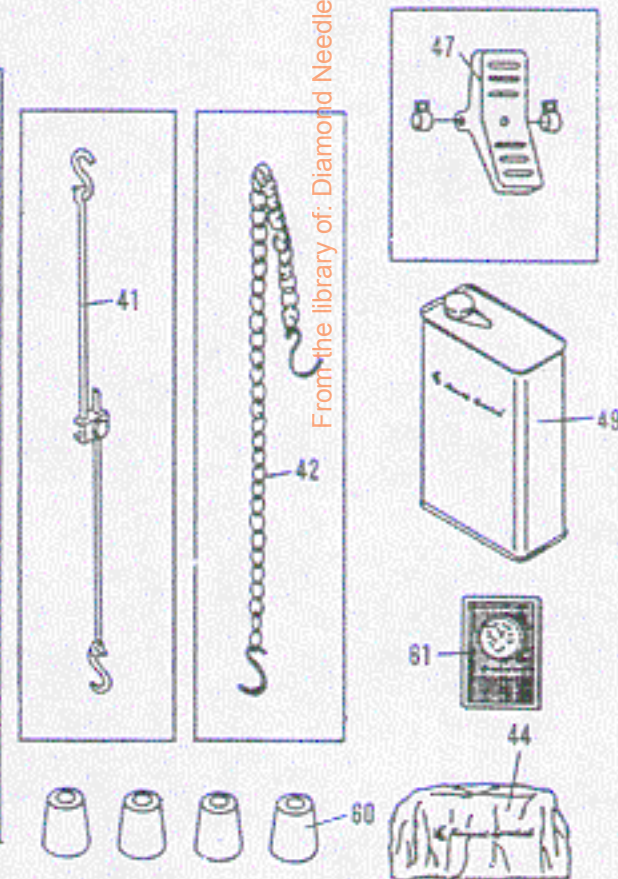

From the library of: Diamond Needle Corp

No.	Part No.	Part Name	品名	Q, ty
1	42-0030-0	Thread stand (3) CS-3	3本糸立	1set
3	42-0080-0	Thread stand (8) CS-8	8本糸立	1set
4	42-0060-0	Thread stand (6) CS-6	6本糸立	1set
5	42-1200-0	Cup	キャップ	1
6	42-1160-0	Thread guide bracket (3)	糸立て台ブラセット (3)	
7		Thread guide bracket (2)	糸立て台ブラケット (2)	
8		Thread guide bracket (3)	糸立て台ブラケット (3)	
9		Screw	ネジ	6
10		Washer	ワッシャ	6
11	42-1130-0	Bar (upper)	糸立て支柱	1
12		Shank	シャンク	1
13		Screw	ネジ	1
14		Nut	ナット	1
15		Screw	ネジ	1
16		Nut	ナット	1
17		Guide thread eyelet arm bar	糸ガイド棒	1
18		Guide thread eyelet	糸道	1
19		Joint	継手	1
20		Screw	ネジ	2
21		Joint	継手	1
22		Screw	ネジ	2
23		Nut	ナット	2
24	42-1120-0	Bar (low)	糸立て支柱	1
25		Base	糸立て土台	2
26		Mounting bracket	糸立てブラケット	6
27		Screw	ネジ	
28		Nut	ナット	
29		Spool pin	糸立てピン	
30		Spool pin retaining fin	糸立て固定具	
31	42-1190-0	Spool mat	クッション	
32	42-1230-0	Spool tray	糸受皿	
33		Nut	ナット	
34		Washer	ワッシャ	
35	42-1150-0	Spool pin bracket (3)	FPL三ッ穴	
36		Spool pin bracket (2)	FPL二ッ穴	
37	42-1150-0	Spool pin bracket (3)	FPL三ッ穴	
38	42-1220-0	Screw	ネジ	3
39	80-7510-0	Screw	モーター取付ネジ	4
41	77-0060-2	Pitman for machine	連結棒	1
42	28-9200-0	Chain	連動クサリ	1
43	28-3100-0	Wrench	六角レンチ 1.5	1
44	28-0210-0	Machine cover	ビニールカバー	1
47	77-0010-2	Pedal for foot lifter	押え揚げペダル	1
49	28-6110-0	Oil (Esso Telesso 33)	マシンオイル	1
50	28-4510-0	Small driver	ドライバー 小	1
51	28-4520-0	Driver	ドライバー 大	1
52	28-0110-0	Tweezers	ピンセット	1
53	28-4210-0	Spanner (small)	スパナ 小	1
54	28-4220-0	Spanner (large)	スパナ 大	1
55	28-3110-0	Wrench A	六角レンチ A 2 ^m /m	1
56	28-3120-0	Wrench B	六角レンチ B 2.5 ^m /m	1
57	28-3130-0	Wrench C	六角レンチ C 3 ^m /m	1
58	28-3140-0	Wrench D	六角レンチ D 5 ^m /m	1
59	28-4640-0	Wrench T type	T型レンチ 10 ^m /m	1
60	31-1610-0	Gam cushion	クッションゴム台	4
61	13-0120-6	UY-128 \pm 12 1902U 1904U 1902-2U type	針	10
	13-0160-6	UY-128 \pm 16 19003U 1900-4U type	針	10
62	42-1810-0	Base	糸立て土台	1

From the library of: Diamond Needle Corp

19. Table stand assembly diagram (テーブルスタンド据付図)

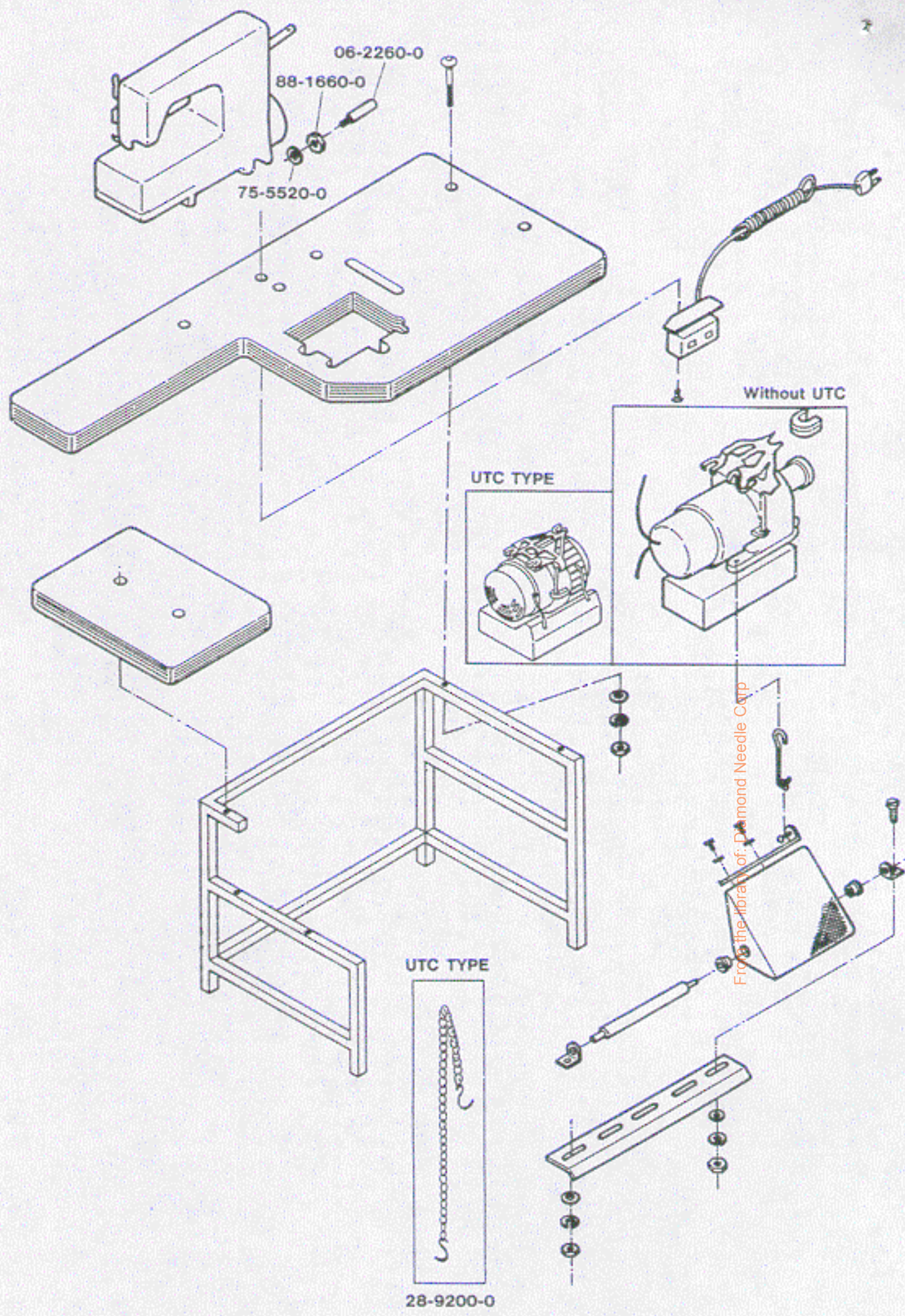

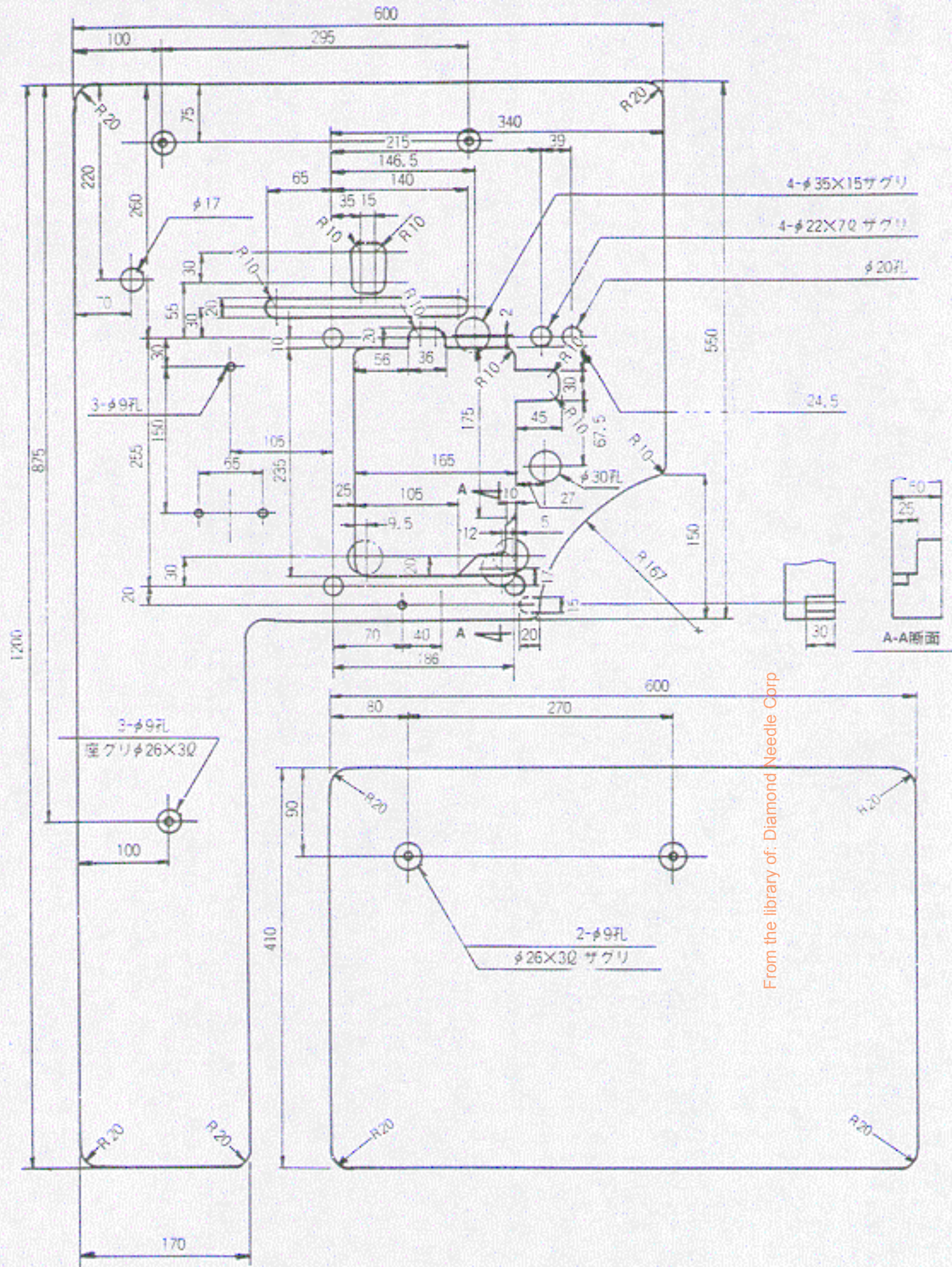

From the library of: Diamond Needle Corp